

ezpoleta 



contract2014

Ezpeleta, en su división Contract, centra sus esfuerzos de diseño y fabricación de parasoles, mobiliario y cojines de exterior para terrazas en el sector de la hostelería. Ezpeleta produce utilizando las tres tecnologías que domina: confección textil, inyección de plásticos, mecanizado y acabado de metal para fabricar **parasoles, bases de parasol, mobiliario y cojines de exterior**. Todos ellos han sido desarrollados prestando la máxima atención a los siguientes requerimientos fundamentales: funcionalidad, comodidad, resistencia a la intemperie, estética contemporánea y excelente relación calidad-precio.

No setor Contract, a Ezpeleta centra os seus esforços no desenho e no fabrico de guarda-sóis, almofadas e mobiliário de exterior para esplanadas no setor da Hotelaria Para a produção de **guarda-sóis, bases para guarda-sóis, almofadas e mobiliário de exterior**, a Ezpeleta utiliza as três tecnologias que domina: confeção têxtil, injeção de plásticos e mecanização com acabamento em metal. Todos os produtos são concebidos prestando a máxima atenção àqueles que consideramos como requisitos fundamentais: Funcionalidade, comodidade, resistência à intempérie, estética contemporânea e excelente relação qualidade-preço.

In its CONTRACT division line, Ezpeleta centres their efforts in the design and production of parasols, furniture and outdoor cushions for terraces in the hospitality trade sector. Ezpeleta uses 3 main production technologies: textile manufacture, plastic injection and metal finishing to manufacture **parasols, parasol bases, furniture and outdoor cushions**. All of them are developed according to these main requirements: functionality, comfort, resistance to bad weather, contemporary design, and excellent value for money.

Dans le marché Contract, Ezpeleta centre ses efforts de dessin et de fabrication de parasols, coussins et mobilier d'extérieur pour terrasses dans le secteur de l'hôtellerie. Ezpeleta produit en utilisant les trois technologies qu'elle domine: confection textile, injection de plastiques, mécanisation et processus de finition de métal pour fabriquer les **parasols, les bases de parasols, les coussins et le mobilier d'extérieur**. Tous conçus tenant compte des suivantes spécifications fondamentales: fonctionnalité, commodité, résistance aux intempéries, esthétique contemporaine, et excellent rapport qualité prix.

Hall	Bali	Niza	Portofino
Park	Capri	Sicilia	Munich
Bowl	Bonaire	Ecologic	Nexus
Cup	Roma	Forest	Salonica
Ozone	Berlin	Monaco	Trebol
			Taba

## Dinning5



## Lounge36

Durban  
Berlin  
Bali  
Tub  
Ibiza Daybed  
Nana Daybed



## Sunlounger50

Spa  
Algarve  
Monaco  
Forest  
Aqua  
Nautic



Ibiza pergola	Ipanema	Formentera
Nova pergola	Río	Bahamas
Moka pergola	Creta	Tenerife
Flexo	Malta	Java
	Vigo	Palloza

## Parasol58



## Complements74

Maui  
Siena  
Bases Parasol



# Dinning

## **SERIES**

Hall

Park

Bowl

Cup

Ozone

Bali

Capri

Bonaire

Roma

Berlin

Niza

Sicilia

Ecologic

Forest

Monaco

Portofino

Munich

Nexus

Salonica

Trebol

Taba





NEW

# Hall



# Hall

MN-HAL00 - 091X00

**ES** Sillón apilable. Polipropileno reforzado con fibra de vidrio antracita. Inyección por gas.

**PT** Cadeira empilhável. Polipropileno reforçado com fibra de vidro antracita. Injeção por gás.

**EN** Stackable armchair. Anthracite fiber glass reinforced polypropylene. Gas injection.

**FR** Fauteuil empilable. Polypropylène renforcé avec fibre de verre anthracite. Injection par gaz.



A 56,5 x B 56 x C 84 cm

colores / cores / colours / couleurs



blanco/branco/white/blanc  
010X00



antracita/anthracite  
091X00



cherry  
042X00



visón/mink  
024X00

cojín recomendado / almofada recomendada / recommended cushion / coussin recommandé

**CAYD005130001P1**

40 x 40 x 3,5+2 cm



# Hall

MS-HAL00 - 010X00

**ES** Silla apilable. Polipropileno reforzado con fibra de vidrio blanco. Inyección por gas.

**PT** Cadeira empilhável. Polipropileno reforçado com fibra de vidro branco. Injeção por gás.

**EN** Stackable chair. White fiber glass reinforced polypropylene. Gas injection.

**FR** Chaise empilable. Polypropylène renforcé avec fibre de verre blanc. Injection par gaz.



A 47 x B 56 x C 84 cm

colores / cores / colours / couleurs



blanco/branco/white/blanc  
010X00



antracita/anthracite  
091X00



cherry  
042X00



visón/mink  
024X00

cojín recomendado / almofada recomendada / recommended cushion / coussin recommandé

**CAYD005130001P1**

40 x 40 x 3,5+2 cm



	MODEL	HALL•PARK	
	DESIGNER	EZPELETA	
REV <input checked="" type="checkbox"/>	MATERIAL	PP+FV	DATE 2013

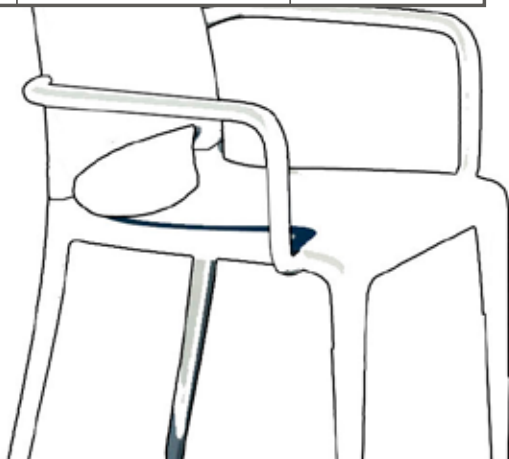

NEW

# Park





# Park MN-PAR00 - 091X00

**ES** Sillón apilable. Polipropileno reforzado con fibra de vidrio antracita. Inyección por gas.

**PT** Cadeira empilhável. Polipropileno reforçado com fibra de vidro antracita. Injeção por gás.

**EN** Stackable armchair. Anthracite fiber glass reinforced polypropylene. Gas injection.

**FR** Fauteuil empilable. Polypropylène renforcé avec fibre de verre anthracite. Injection par gaz.



A 56,5 x B 56 x C 84 cm

colores / cores / colours / couleurs



blanco/branco/white/blanc  
010X00



antracita/anthracite  
091X00



cherry  
042X00



visón/mink  
024X00

cojín recomendado / almofada recomendada / recommended cushion / coussin recommandé

**CAYD005130001P1**

40 x 40 x 3,5+2 cm



# Park MS-PAR00 - 042X00

**ES** Silla apilable. Polipropileno reforzado con fibra de vidrio rojo. Inyección por gas.

**PT** Cadeira empilhável. Polipropileno reforçado com fibra de vidro vermelho. Injeção por gás.

**EN** Stackable chair. Red fiber glass reinforced polypropylene. Gas injection.

**FR** Chaise empilable. Polypropylène renforcé avec fibre de verre rouge. Injection par gaz.



A 47 x B 56 x C 84 cm

colores / cores / colours / couleurs



blanco/branco/white/blanc  
010X00



antracita/anthracite  
091X00



cherry  
042X00



visón/mink  
024X00

cojín recomendado / almofada recomendada / recommended cushion / coussin recommandé

**CAYD005130001P1**

40 x 40 x 3,5+2 cm



	MODEL	HALL•PARK	
	DESIGNER	EZPELETA	
REV <input checked="" type="checkbox"/>	MATERIAL	PP+FV	DATE 2013

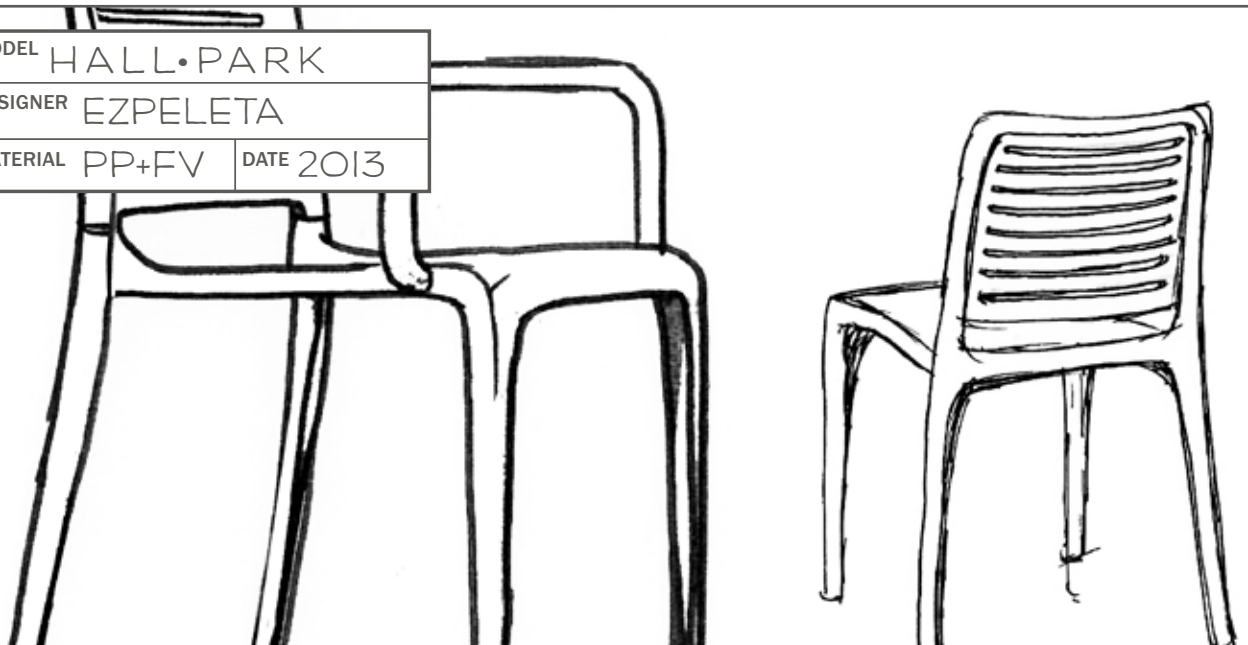

# Bowl - Cup - Ozone



## Bowl MN-BOW01-010X00/MN-BOW02-023X00

**ES** Sillón apilable. Polipropileno copolímero blanco, óxido. Patas de aluminio pintado blanco, óxido.

**PT** Cadeira empilhável. Polipropileno copolímero branco, óxido. Pés em alumínio pintado branco, óxido.

**EN** Stackable armchair. White, rust copolymer polypropylene. White, rust painted aluminium legs.

**FR** Fauteuil empilable. Copolymère polypropylène blanc, rouille. Pieds en aluminium peint blanc, rouille.

A 58 x B 53 x C 82 cm

colores / cores / colours / couleurs



blanco/branco/white/blanc  
010X00



óxido/rust/rouille  
023X00



cojín recomendado / almofada recomendada / recommended cushion / coussin recommandé

**CAYD002670000P1**

45 X 45 X 3,5 + 2 cm



## Cup MN-CUP01-023X00/MN-CUP02-010X00

**ES** Sillón apilable. Polipropileno copolímero blanco, óxido. Patas de aluminio pintado blanco, óxido.

**PT** Cadeira empilhável. Polipropileno copolímero branco, óxido. Pés em alumínio pintado branco, óxido.

**EN** Stackable armchair. White, rust copolymer polypropylene. White, rust painted aluminium legs.

**FR** Fauteuil empilable. Copolymère polypropylène blanc, rouille. Pieds en aluminium peint blanc, rouille.

A 58 x B 50 x C 79 cm

colores / cores / colours / couleurs



blanco/branco/white/blanc  
010X00



óxido/rust/rouille  
023X00



cojín recomendado / almofada recomendada / recommended cushion / coussin recommandé

**CAYD002670000P1**

45 X 45 X 3,5 + 2 cm



## Ozone MN-OZ005-090X00/MN-OZ003-010X00 MN-OZ004-023X00

**ES** Sillón apilable. Polipropileno copolímero blanco, óxido o negro. Patas de aluminio pintado blanco, óxido o negro.

**PT** Cadeira empilhável. Polipropileno copolímero branco, óxido ou preto. Pés em alumínio pintado branco, óxido ou preto.

**EN** Stackable armchair. White, rust or black copolymer polypropylene. White, rust or black painted aluminium legs.

**FR** Fauteuil empilable. Copolymère polypropylène blanc, rouille ou noire. Pieds en aluminium peint blanc, rouille ou noire.

A 56 x B 54 x C 85 cm

colores / cores / colours / couleurs



blanco/branco/white/blanc  
010X00



óxido/rust/rouille  
023X00



negro/preto/black/noire  
090X00



cojín recomendado / almofada recomendada / recommended cushion / coussin recommandé

**CAYD002670000P1**

45 X 45 X 3,5 + 2 cm



# Bali



## Bali MR-BAL00-023R31

ES Sillón respaldo alto. Aluminio. Ratán plano rústico marrón.

PT Cadeira encosto alto. Alumínio. Ratan plano rústico castanho.

EN High-backrest armchair. Aluminium. Flat rustic brown rattan.

FR Fauteuil haut dossier. Aluminium. Rattan plat rustique marron.

A 57 x B 60 x C 85 cm

cojín recomendado / almofada recomendada / recommended cushion /  
coussin recommandé

**CPR-BALD00000P1**

46/40 x 43 x 5 cm



## Bali MN-BAL00-023R31

ES Sillón apilable. Aluminio. Ratán plano rústico marrón.

PT Cadeira empilhável. Alumínio. Ratan plano rústico castanho.

EN Stackable armchair. Aluminium. Flat rustic brown rattan.

FR Fauteuil empilable. Aluminium. Rattan plat rustique marron.

A 57 x B 60 x C 85 cm

cojín recomendado / almofada recomendada / recommended cushion /  
coussin recommandé

**CAED008160011P1**

42 x 42 x 5 cm



## Bali MS-BAL00-023R31

ES Silla apilable. Aluminio. Ratán plano rústico marrón.

PT Cadeira empilhável. Alumínio. Ratan plano rústico castanho.

EN Stackable chair. Aluminium. Flat rustic brown rattan.

FR Chaise empilable. Aluminium. Rattan plat rustique marron.

A 46 x B 53 x C 87 cm

cojín recomendado / almofada recomendada / recommended cushion /  
coussin recommandé

**CAED008160011P1**

42 x 42 x 5 cm



# Capri - Bonaire



## Capri MN-CAP00-023R31

ES Sillón apilable. Aluminio. Ratán plano rústico marrón.

PT Cadeira empilhável. Alumínio. Ratan plano rústico castanho.

EN Stackable armchair. Aluminium. Flat rustic brown rattan.

FR Fauteuil empilable. Aluminium. Rattan plat rustique marron.

A 56 x B 61 x C 81 cm

cojín recomendado / almofada recomendada / recommended cushion /  
coussin recommandé

**CAED00816001P1**

42 x 42 x 5 cm



## Bonaire MN-BON00-021R50

ES Sillón apilable. Aluminio. Ratán café 4 vías.

PT Cadeira empilhável. Alumínio. Ratan café 4 vías.

EN Stackable armchair. Aluminium. 4 in 1 coffee rattan.

FR Fauteuil empilable. Aluminium. Rattan café 4 lignes.

A 55 x B 49 x C 76,5 cm

cojín recomendado / almofada recomendada / recommended cushion /  
coussin recommandé

**CAYD005130001P1**

40 x 40 x 3,5+2 cm



## Bonaire MN-BON00-090R50

ES Sillón apilable. Aluminio. Ratán negro 4 vías.

PT Cadeira empilhável. Alumínio. Ratan preto 4 vías.

EN Stackable armchair. Aluminium. 4 in 1 black rattan.

FR Fauteuil empilable. Aluminium. Rattan noir 4 lignes.

A 55 x B 49 x C 76,5 cm

cojín recomendado / almofada recomendada / recommended cushion /  
coussin recommandé

**CAYD005130001P1**

40 x 40 x 3,5+2 cm



# Roma





## Roma MN-ROM00-010R50

ES Sillón apilable. Aluminio. Ratán blanco 4 vías.

PT Cadeira empilhável. Alumínio. Ratan branco 4 vías.

EN Stackable armchair. Aluminium. 4 in 1 white rattan.

FR Fauteuil empilable. Aluminium. Rattan blanc 4 lignes.

A 64,5 x B 60 x C 79 cm

cojín recomendado / almofada recomendada / recommended cushion /  
coussin recommandé

**CPN-ROMD00000C1**

50 x 48,5 x 5 cm



## Roma MN-ROM00-090R50

ES Sillón apilable. Aluminio. Ratán negro 4 vías.

PT Cadeira empilhável. Alumínio. Ratan preto 4 vías.

EN Stackable armchair. Aluminium. 4 in 1 black rattan.

FR Fauteuil empilable. Aluminium. Rattan noir 4 lignes.

A 64,5 x B 60 x C 79 cm

cojín recomendado / almofada recomendada / recommended cushion /  
coussin recommandé

**CPN-ROMD00000C1**

50 x 48,5 x 5 cm



## Roma MN-ROM00-021R50

ES Sillón apilable. Aluminio. Ratán café 4 vías.

PT Cadeira empilhável. Alumínio. Ratan café 4 vías.

EN Stackable armchair. Aluminium. 4 in 1 coffee rattan.

FR Fauteuil empilable. Aluminium. Rattan café 4 lignes.

A 64,5 x B 60 x C 79 cm

cojín recomendado / almofada recomendada / recommended cushion /  
coussin recommandé

**CPN-ROMD00000C1**

50 x 48,5 x 5 cm



# Berlín - Niza

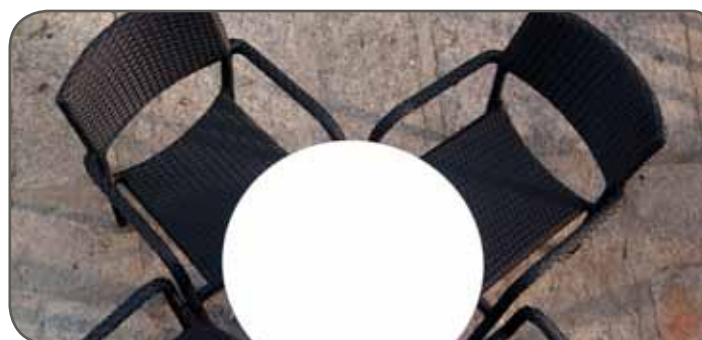

## Berlín MN-BER01-010R50

ES Sillón apilable. Aluminio. Ratán blanco 4 vías.

PT Cadeira empilhável. Alumínio. Ratan branco 4 vías.

EN Stackable armchair. Aluminium. 4 in 1 white rattan.

FR Fauteuil empilable. Aluminium. Rattan blanc 4 lignes.

A 57 x B 61,5 x C 91 cm

cojín recomendado / almofada recomendada / recommended cushion /  
coussin recommandé

**CAED008160011P1**

42 x 42 x 5 cm



## Berlín MN-BER01-091R50

ES Sillón apilable. Aluminio. Ratán antracita 4 vías.

PT Cadeira empilhável. Alumínio. Ratan antracita 4 vías.

EN Stackable armchair. Aluminium. 4 in 1 anthracite rattan.

FR Fauteuil empilable. Aluminium. Rattan anthracite 4 lignes.

A 57 x B 61,5 x C 91 cm

cojín recomendado / almofada recomendada / recommended cushion /  
coussin recommandé

**CAED008160011P1**

42 x 42 x 5 cm



## Niza MN-NIZ00-090R50

ES Sillón apilable. Aluminio. Ratán negro 4 vías.

PT Cadeira empilhável. Alumínio. Ratan preto 4 vías.

EN Stackable armchair. Aluminium. 4 in 1 black rattan.

FR Fauteuil empilable. Aluminium. Rattan noir 4 lignes.

A 55 x B 61 x C 83 cm

cojín recomendado / almofada recomendada / recommended cushion /  
coussin recommandé

**CAED008160011P1**

42 x 42 x 5 cm



# Sicilia



## Sicilia MN-SIC00-020J00

ES Sillón apilable. Aluminio pintado taupe. Lamas asiento en eco-wood taupe.

PT Cadeira empilhável. Alumínio pintado taupe. Ripas assento em eco-wood taupe.

EN Stackable armchair. Taupe painted aluminium. Eco-wood seat slats in taupe.

FR Fauteuil empilable. Aluminium peint taupe. Lamelles siège eco-wood couleur taupe.

A 51 x B 55 x C 82 cm

cojín recomendado / almofada recomendada / recommended cushion /  
coussin recommandé

**CAYD005130001P1**

40 x 40 x 3,5+2 cm



## Sicilia MN-SIC00-040J00

ES Sillón apilable. Aluminio pintado óxido. Lamas asiento en eco-wood óxido.

PT Cadeira empilhável. Alumínio pintado óxido. Ripas assento em eco-wood óxido.

EN Stackable armchair. Rust painted aluminium. Eco-wood seat slats in rust.

FR Fauteuil empilable. Aluminium peint oxyde. Lamelles siège eco-wood couleur rouille.

A 51 x B 55 x C 82 cm

cojín recomendado / almofada recomendada / recommended cushion /  
coussin recommandé

**CAYD005130001P1**

40 x 40 x 3,5+2 cm



# Ecologic - Forest



## Ecologic MN-EC000-020J00

ES Sillón apilable. Aluminio pintado taupe. Lamas eco-wood color taupe.

PT Cadeira empilhável. Alumínio pintado taupe. Ripas eco-wood cor taupe.

EN Stackable armchair. Taupe painted aluminium. Taupe eco-wood slats.

FR Fauteuil empilable. Aluminium peint taupe. Lamelles eco-wood couleur taupe.

A 56,5 x B 53 x C 85 cm

cojín recomendado / almofada recomendada / recommended cushion /  
coussin recommandé

**CAED008160011P1**

42 x 42 x 5 cm



## Forest MN-FOR00

ES Sillón plegable. Balau amarillo.

PT Cadeira dobrável. Balau amarelo.

EN Folding armchair. Yellow balau.

FR Fauteuil pliante. Balau tropical jaune.

A 56 x B 59 x C 89,5 cm

cojín recomendado / almofada recomendada / recommended cushion /  
coussin recommandé

**CPN-FORD00000C2**

92 (51+41) x 45 x 4+2 cm



## Forest MS-FOR00

ES Silla plegable. Balau amarillo.

PT Cadeira dobrável. Balau amarelo.

EN Folding chair. Yellow balau.

FR Chaise pliante. Balau tropical jaune.

A 46 x B 59 x C 89,5 cm

cojín recomendado / almofada recomendada / recommended cushion /  
coussin recommandé

**CPS-FORD00000C1**

47 x 38 x 4+2 cm



# Mónaco





## Mónaco MN-MON00-090T21

ES Sillón apilable. Aluminio pintado gris. Textilene. Reposabrazos de eco-wood.

PT Cadeira empilhável. Alumínio pintado cinza. Textilene. Reposa braços de eco-wood.

EN Stackable armchair. Grey aluminium. Textilene. Eco-wood armrests.

FR Fauteuil empilable. Aluminium peint gris. Textilene. Repose-bras en eco-wood.

A 56,5 x B 53 x C 85 cm

colores / cores / colours / couleurs



blanco/branco/white/blanc  
010T21



rojo/vermelho/red/rouge  
040T21



gris/cinza/grey/gris  
030T21



beige/bege  
001T21



negro/preto/black/noir  
090T21



## Mónaco 80X80/70X70/120X70 42MON10/42MON00/42MON100

ES Mesa apilable. Pata de aluminio pintado gris. Estructura soldada. Reguladores de altura.

PT Mesa empilhável. Alumínio. Pé de alumínio pintado cinza. Estrutura soldada. Reguladores de altura.

EN Stackable table. Legs in grey painted aluminium. Welded frame. Adjustable leveling feet.

FR Table empilable. Pieds aluminium peint gris. Structure soudée. Régulateurs d'hauteur.

A 80 x B 80 x C 73 cm - A 70 x B 70 x C 73 cm - A 120 x B 70 x C 73 cm (compact)

tableros / tampos / tops / plateaux

- Werzalit  
- Compacto



**werzalit**  
STRUKTUR - RESISTENTE

**COMPACTO**



## Mónaco 70X70/80X80/120X70 42MON02/42MON12/42MON102

ES Mesa apilable. Pata de aluminio pintado negra. Estructura soldada. Reguladores de altura.

PT Mesa empilhável. Pé de alumínio pintado preto. Estrutura soldada. Reguladores de altura.

EN Stackable table. Black painted aluminium legs. Welded frame. Adjustable leveling feet.

FR Table empilable. Pieds aluminium peint noir. Structure soudée. Régulateurs d'hauteur.

A 70 x B 70 x C 73 cm - A 80 x B 80 x C 73 cm - A 120 x B 70 x C 73 cm (compact)

tableros / tampos / tops / plateaux

- Werzalit  
- Compacto



**werzalit**  
STRUKTUR - RESISTENTE

**COMPACTO**



# Mónaco



## Mónaco 120X70/70X70/80X80

42MON104/42MON04/42MON14

ES Mesa apilable. Pata de aluminio pintado blanco. Estructura soldada. Reguladores de altura.

PT Mesa empilhável. Pé de alumínio pintado branco. Estrutura soldada. Reguladores de altura.

EN Stackable table. Legs in white painted aluminium. Welded frame. Adjustable leveling feet.

FR Table empilable. Pieds aluminium peint blanc. Structure soudée. Régulateurs d'hauteur.

A 70 x B 70 x C 73 cm - A 80 x B 80 x C 73 cm - A 120 x B 70 x C 73 cm (compact)

tableros / tampos / tops / plateaux

- Werzalit

- Compacto



**werzalit**  
REFRACTIVO - RESISTENTE

**COMPACT**

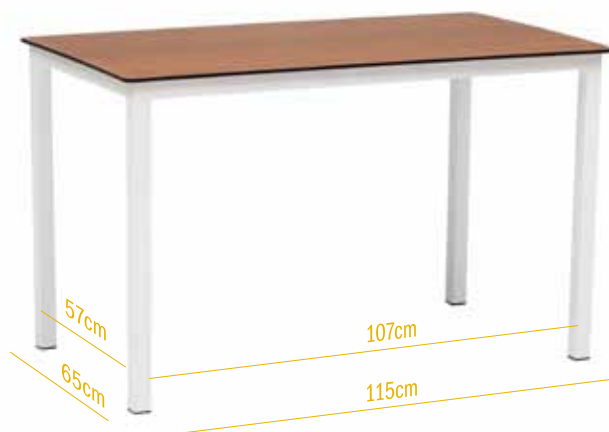

## Mónaco 80X80/70X70/120X70

42MON13/42MON03/42MON103

ES Mesa apilable. Pata de aluminio pintado óxido. Estructura soldada. Reguladores de altura.

PT Mesa empilhável. Pé de alumínio pintado óxido. Estrutura soldada. Reguladores de altura.

EN Stackable table. Rust painted aluminium legs. Welded frame. Adjustable leveling feet.

FR Table empilable. Pieds aluminium peint oxyde. Structure soudée. Régulateurs d'hauteur.

A 70 x B 70 x C 73 cm - A 80 x B 80 x C 73 cm - A 120 x B 70 x C 73 cm (compact)

tableros / tampos / tops / plateaux

- Werzalit

- Compacto



**werzalit**  
REFRACTIVO - RESISTENTE

**COMPACT**



## Portofino 80X80/90X90/160X90

ES Mesa apilable. Pata de aluminio pintado blanco o negro. Reguladores de altura.

PT Mesa empilhável. Pé de alumínio pintado branco ou preto. Reguladores de altura.

EN Stackable table. Black or white painted aluminium legs. Adjustable leveling feet.

FR Table empilable. Pieds aluminium peint noir et blanc. Régulateurs d'hauteur.

A 80 x B 80 x C 73 cm - A 90 x B 90 x C 73 cm - A 160 x B 90 x C 73 cm

colores / cores / colours / couleurs

blanco/branco/white/blanc  
42POR00-80X80  
42POR10-90X90  
42POR20-160X90

negro/preto/black/noir  
42POR01-80X80  
42POR11-90X90  
42POR21-160X90



**COMPACT**



**Bali** 70X70 MD-BAL00-023R31  
90X90 MD-BAL01-023R31

ES Mesa Dinning Tablero de teka. Aluminio. Ratán plano rústico marrón.

PT Mesa Dinning. Tampo de Teka. Alumínio. Ratan plano rústico castanho.

EN Dinning table. Teak table top. Aluminium. Flat rustic brown rattan.

FR Table Dinning. Plateau en teck. Aluminium. Rattan plat rustique marron.

A 70 x B 70 x C 73 cm - A 90 x B 90 x C 73 cm



**Bali** 150X90 MD-BAL02-023R31

ES Mesa Dinning Tablero de teka. Aluminio. Ratán plano rústico marrón.

PT Mesa Dinning. Tampo de Teka. Alumínio. Ratan plano rústico castanho.

EN Dinning table. Teak table top. Aluminium. Flat rustic brown rattan.

FR Table Dinning. Plateau en teck. Aluminium. Rattan plat rustique marron.

A 150 x B 90 x C 73 cm



## Forest 70X70 MD-FOR00

ES Mesa Dinning plegable. Balau amarillo.

PT Mesa Dinning dobrável. Balau amarelo.

EN Folding Dinning table. Yellow balau.

FR Table Dinning pliante. Balau tropical jaune.

A 70 x B 70 x C 75 cm



## Forest 80X80 MD-FOR03

ES Mesa Dinning plegable. Balau amarillo.

PT Mesa Dinning dobrável. Balau amarelo.

EN Folding Dinning table. Yellow balau.

FR Table Dinning pliante. Balau tropical jaune.

A 80 x B 80 x C 75 cm



## Forest 100X100 MD-FOR01

ES Mesa Dinning plegable. Balau amarillo. Con alojamiento para parasol.

PT Mesa Dinning dobrável. Balau amarelo. Com furo para guarda-sol.

EN Folding Dinning table. Yellow balau. With parasol hole.

FR Table Dinning pliante. Balau tropical jaune. Avec trou pour parasol.

A 100 x B 100 x C 75 cm



## Berlín 80X80 MD-BER00-010R50

- ES Mesa Dinning. Aluminio. Ratán blanco 4 vías. Con cristal.
- PT Mesa Dinning. Alumínio. Ratan branco 4 vías. Com vidro.
- EN Dinning table. Aluminium. 4 in 1 white rattan. With glass.
- FR Table Dinning. Aluminium. Rattan blanc 4 lignes. Avec verre.

A 80 x B 80 x C 75 cm - tubo/tube 11X11 cm



## Bonaire Ø60/Ø70/60X60/70X70 42B0N02

- ES Mesa Pata central. Aluminio. Ratán negro 4 vías.
- PT Mesa pé central. Alumínio. Ratan preto 4 vías.
- EN Central leg table. Aluminium. 4 in 1 black rattan.
- FR Table pied central. Aluminium. Rattan noir 4 lignes.

Ø60 x 76 cm - A 60 x B 60 x C 76 cm - Ø70 x 76 cm - A 70 x B 70 x C 76 cm  
- tubo/tube 10X10 cm

tableros / tampos / tops / plateaux  
- **Werzalit**



**werzalit**  
KERATINO - RESISTENTE



## Bonaire Ø60/Ø70/60X60/70X70 42B0N01

- ES Mesa pata central. Aluminio. Ratán café 4 vías.
- PT Mesa pé central. Alumínio. Ratan café 4 vías.
- EN Central leg table. Aluminium. 4 in 1 coffee rattan.
- FR Table pied central. Aluminium. Rattan café 4 lignes.

Ø60 x 76 cm - A 60 x B 60 x C 76 cm - Ø70 x 76 cm - A 70 x B 70 x C 76 cm  
- tubo/tube 10X10 cm

tableros / tampos / tops / plateaux  
- **Werzalit**



**werzalit**  
KERATINO - RESISTENTE



## Munich $\varnothing 60/60 \times 60 / \varnothing 70/70 \times 70$ 42MUB00

ES Mesa abatible. Acabado Inox.

PT Mesa abatível. Acabado Inox.

EN Folding table. Stainless steel finishing.

FR Table pliante. Finition en inox.

$\varnothing 60 \times 73$  cm - A 60 x B 60 x C 73 cm - tubo/tube  $\varnothing 70$  mm  
 $\varnothing 70 \times 73$  cm - A 70 x B 70 x C 73 cm - tubo/tube  $\varnothing 70$  mm

tableros / tampos / tops / plateaux

- Werzalit  
- Compacto



**werzalit**  
ATTRACTIVE - RESISTENTE

**COMPACTO**



## Nexus 60X60/70X70/80X80 42NEX00

ES Mesa con pie central. Inox.

PT Mesa com pé central. Inox.

EN Table with central leg. Stainless steel.

FR Table avec pied central. Inox

A 60 x B 60 x C 73 cm - tubo/tube 80x80x1,5 mm  
A 70 x B 70 x C 73 cm - tubo/tube 80x80x1,5 mm  
A 80 x B 80 x C 73 cm - tubo/tube 80x80x1,5 mm

tableros / tampos / tops / plateaux

- Inox  
- Werzalit



**INOX**

**werzalit**  
ATTRACTIVE - RESISTENTE



## Salónica $\varnothing 60 / \varnothing 70$ 42SAL00

ES Mesa inox con pie central.

PT Mesa inox com pé central.

EN Stainless steel table with central leg.

FR Table inox avec pied central.

$\varnothing 60 \times 73$  cm - tubo/tube 76x1,5 mm -  $\varnothing 70 \times 73$  cm - tubo/tube 76x1,5 mm

tableros / tampos / tops / plateaux

- Inox  
- Werzalit



**INOX**

**werzalit**  
ATTRACTIVE - RESISTENTE



NEW

# Trebol - Taba





## Trebol $\varnothing 60/60 \times 60/\varnothing 70/70 \times 70$ 42TRE00/42TRE01

ES Mesa abatible. Acero pintado blanco o negro. Reguladores de altura.

PT Mesa abatível. Aço pintado branco o preto. Reguladores de altura.

EN Folding table. White or black painted steel. Adjustable leveling feet.

FR Table pliante. Acier peint blanc et noir. Régulateurs d'hauteur.

$\varnothing 60 \times 73$  cm - A 60 x B 60 x C 73 cm - tubo/tube  $\varnothing 70$  mm  
 $\varnothing 70 \times 73$  cm - A 70 x B 70 x C 73 cm - tubo/tube  $\varnothing 70$  mm

colores / cores / colours / couleurs



blanco/branco/white/blanc  
42TRE00



negro/preto/black/noir  
42TRE01



**werzalit**  
ATTRACTIVO - RESISTENTE

**COMPACT**



## Taba $\varnothing 60/60 \times 60/\varnothing 70/70 \times 70$ 42TAB00/42TAB10 - 42TAB01/42TAB11

ES Mesa abatible. Acero pintado blanco o negro. Reguladores de altura.

PT Mesa abatível. Aço pintado branco o preto. Reguladores de altura.

EN Folding table. White or black painted steel. Adjustable leveling feet.

FR Table pliante. Acier peint blanc et noir. Régulateurs d'hauteur.

$\varnothing 60 \times 73$  cm - A 60 x B 60 x C 73 cm - tubo/tube  $\varnothing 70$  mm  
 $\varnothing 70 \times 73$  cm - A 70 x B 70 x C 73 cm - tubo/tube  $\varnothing 70$  mm  
 $\varnothing 60 \times 113$  cm - A 60 x B 60 x C 113 cm - tubo/tube  $\varnothing 70$  mm

colores / cores / colours / couleurs



blanco/branco/white/blanc  
42TAB00  
42TAB10 (alta/high/haute)



negro/preto/black/noir  
42TAB01  
42TAB11 (alta/high/haute)



**COMPACT**

**werzalit**  
ATTRACTIVO - RESISTENTE

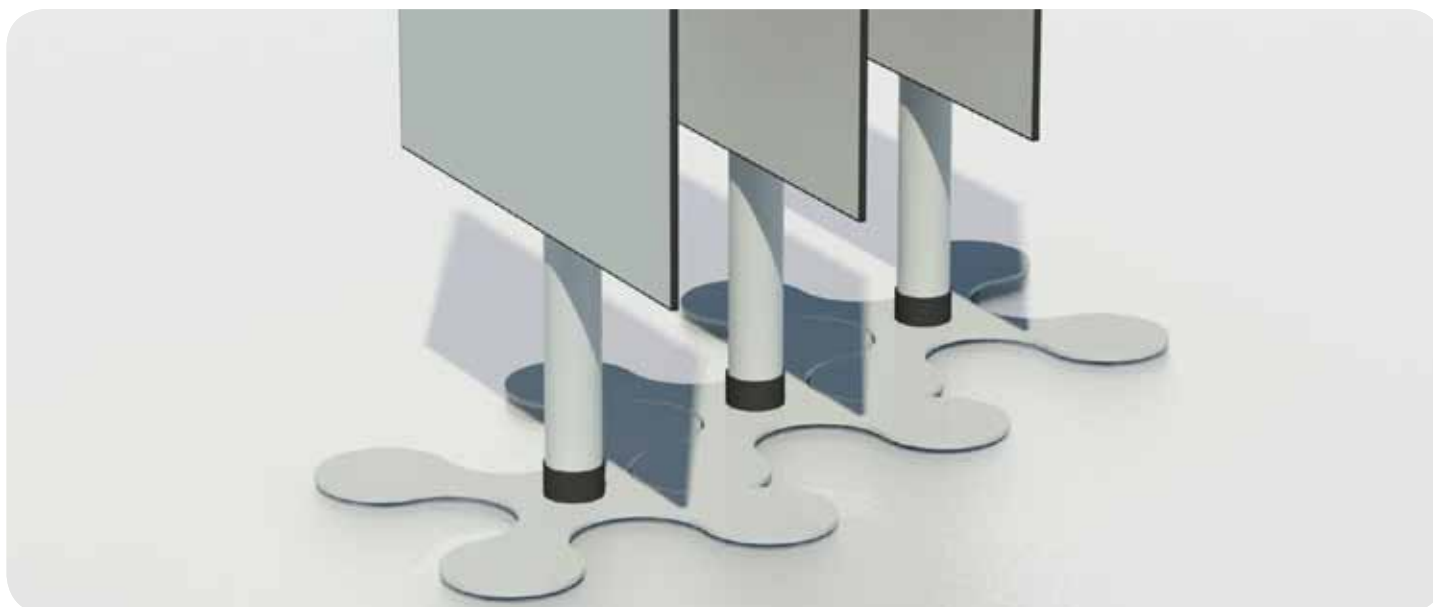

# Bali

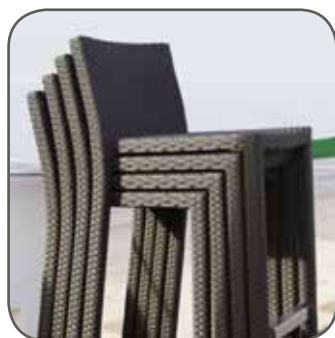
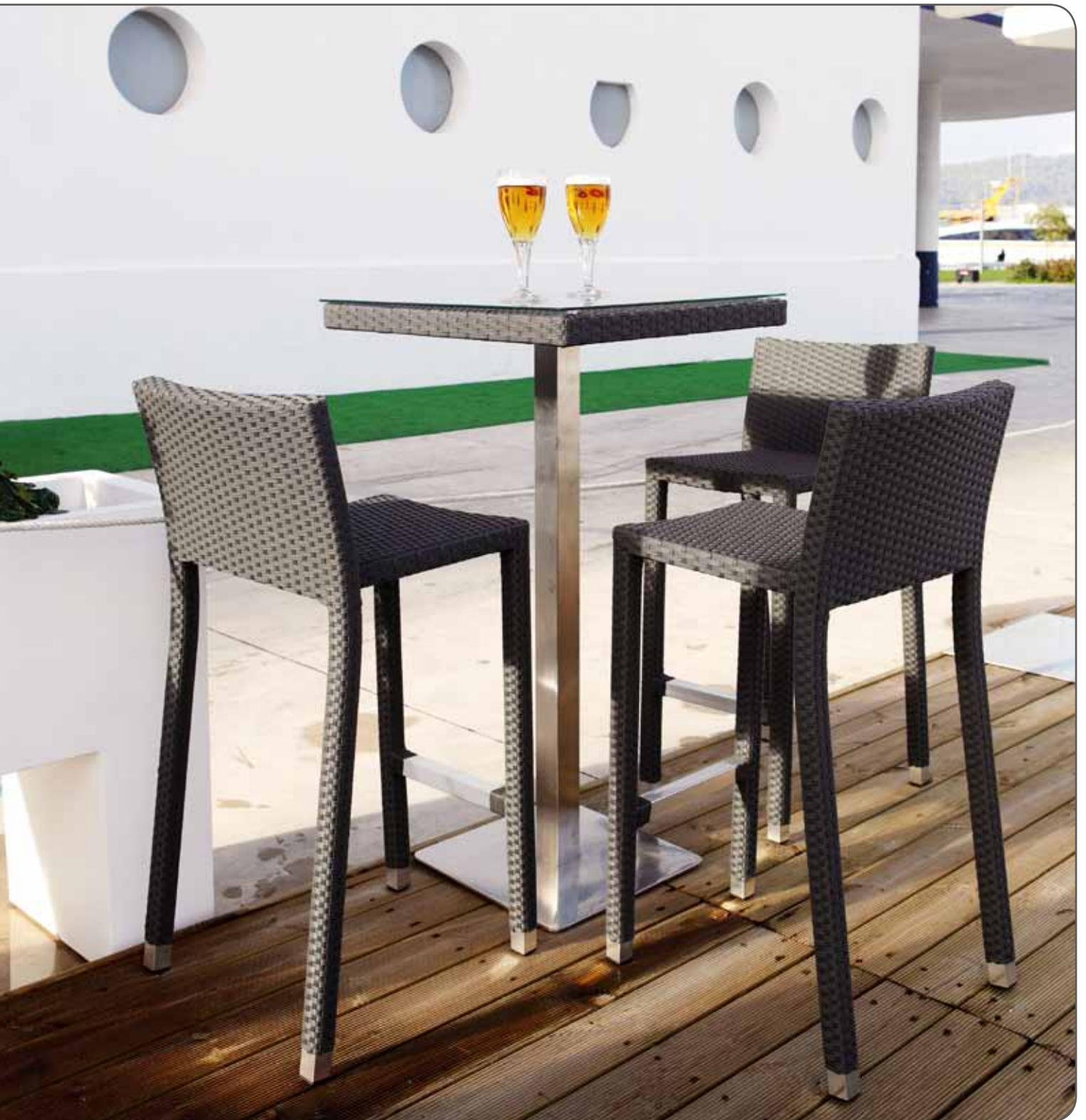

## Bali MT-BAL01-023R31

ES Taburete apilable con respaldo. Aluminio. Ratán plano rústico marrón.

PT Banco alto empilhável com encosto. Alumínio. Ratan plano rústico castanho.

EN Stackable stool with backrest. Aluminium. Flat rustic brown rattan.

FR Tabouret empilable avec dossier. Aluminium. Rattan plat rustique marron.

A 45 x B 42 x C 95 cm



## Berlín MT-BER01-091R50

ES Taburete apilable con respaldo. Aluminio. Ratán antracita 4 vías.

PT Banco alto empilhável com encosto. Alumínio. Ratan antracita 4 vías.

EN Stackable stool with backrest. Aluminium. 4 in 1 anthracite rattan.

FR Tabouret empilable avec dossier. Aluminium. Rattan anthracite 4 lignes.

A 45 x B 42 x C 95 cm

colores / cores / colours / couleurs

blanco/branco/white/blanc  
010R50

antracita/anthracite  
091R50



## Mónaco 60X60 42MON60 - 42MON63 42MON62 - 42MON64

ES Mesa apilable. Pata de aluminio en blanco, gris, óxido o negro.

PT Mesa empilhável. Pé de alumínio cor branco, cinza, óxido ou preto.

EN Stackable table. Legs in white, grey, rust or black, painted aluminium.

FR Table empilable. Pieds aluminium blanc, gris, rouille ou noire.

A 60 x B 60 x C 105 cm

colores / cores / colours / couleurs

gris/cinza/gray/gris  
42MON60

óxido/rust/rouille  
42MON63

negro/preto/black/noire  
42MON62

blanco/branco/white/blanc  
42MON64



**COMPACT**



## Berlín 60X60 ML-BER00-091R50

ES Mesa Alta. Aluminio. Ratán antracita 4 vías. Pata central aluminio acabado inox. Con cristal

PT Mesa alta. Alumínio. Ratan antracita 4 vías. Pé central alumínio acabado inox. Com vidro.

EN High table. 4 in 1 anthracite rattan. Aluminium central leg inox finishing. With glass.

FR Table Haute. Aluminium. Rattan anthracite 4 lignes. Pied central aluminium finition inox. Avec verre.

A 60 x B 60 x C 108 cm - tubo/tube 6X6 cm

colores / cores / colours / couleurs



blanco/branco/white/blanc  
010R50



antracita/anthracite  
091R50



## Bali 60X60 ML-BAL01-023R31

ES Mesa Alta. Aluminio. Ratán plano rústico marrón. Pata central aluminio acabado inox. Con cristal

PT Mesa alta. Alumínio. Ratan plano rústico castanho. Pé central alumínio acabado inox. Com vidro.

EN High table. Flat rustic brown rattan. Aluminium central leg inox finishing. With glass.

FR Table Haute. Aluminium. Rattan plat rustique marron. Pied central aluminium finition inox. Avec verre.

A 60 x B 60 x C 108cm - tubo/tube 6X6 cm



## Munich Ø60/60X60/Ø70/70X70 42MUA00

ES Mesa alta abatible. Aluminio acabado Inox.

PT Mesa alta abatível. Alumínio acabado Inox.

EN Folding high table. Aluminium Inox finishing.

FR Table haute pliante. Aluminium finition Inox.

Ø60 x 114 cm - A 60 x B 60 x C 114 cm - tubo/tube Ø70 mm

Ø70 x 114 cm - A 70 x B 70 x C 114 cm - tubo/tube Ø70 mm

tableros / tampos / tops / plateaux

- Werzalit

- Compacto



**werzalit**  
ATTRACTIVE - RESISTENTE

**COMPACTO**

**ES** Su superficie plana y cerrada, que se compacta homogéneamente con el material derivado de la madera, resulta fácil de limpiar y cumple todos los requisitos de higiene de la gastronomía profesional.

- Estables y robustos.
- Superficie sin juntas y fácil de cuidar.
- Resistentes a la intemperie y a los rayos UV.
- Resistentes al calor.

Para las mesas que están especialmente expuestas al sol se recomiendan decorados claros.

**PT** A sua superfície plana e fechada, compacta de forma homogénea com o material derivado da madeira, permite uma limpeza fácil cumprindo desta forma com todos os requisitos a nível de higiene no sector da gastronomia profissional.

- Estável e robusto.
- Superfície sem juntas e de fácil manutenção.
- Resistente à intempérie e aos raios UV.
- Resistente ao calor.

Para as mesas especialmente expostas ao sol, são recomendadas decorações claras.

**EN** The smooth, closed surface homogeneously pressed onto the wood substrat is easy to clean and satisfies hygiene requirements of the professional food service industry.

- Stable and robust.
- Seamless surface that is easy to care.
- Weather-proof and UV-resistant.
- Heat-resistant.

We recommend lighter decors for tables that are exposed to significant sunlight.

**FR** Sa surface lisse et fermée, pressée de manière homogène avec du bois, se nettoie facilement permettant ainsi de répondre aux exigences au niveau de l'hygiène, dans le secteur de la gastronomie professionnelle.

- Stable et robuste.
- Une surface sans joints et d'entretien aisé.
- Résistance aux UV et aux intempéries.
- Résistance à la chaleur.

Nous déconseillons les décors foncés pour les tables exposées au soleil.



## GRUPO 1



## GRUPO 2

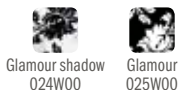

# Compacto

## COMPACT

**ES** Tablero termolaminado compacto decorativo. Formado en la cara exterior por papel decorativo impregnado y en el interior por papel kraft impregnado con resinas termoestables. Se aplica en prensa temperatura y presión de forma simultánea para conseguir un tablero compacto de alta densidad.

**PT** Tampo termolaminado compacto decorativo. Formado na sua face exterior por papel decorativo impregnado e no seu interior por papel kraft impregnado com resinas termoestáveis. O conjunto é prensado por meio de calor e alta pressão de forma simultânea para conseguir um tampo compacto de alta densidade.

**EN** Pressed laminated table top. Interior composition of thermostable resin kraft paper. Surface lined with impregnated decorative paper. The composite is pressed high temperature and pressure simultaneously to obtain a high density compacted table top.

**FR** Plateau stratifié compact décoratif. Formé sur sa face extérieure par du papier décoratif imprégné et dans son intérieur par du papier kraft imprégné avec des résines thermostables. L'ensemble est ensuite pressé sous l'action de la chaleur et de la haute pression, simultanément, afin d'obtenir un plateau compact de haute densité.



# Inox

## INOX

**ES** Tablero aglomerado hidrófugo con sobre de acero inoxidable

**PT** Tampo de painel aglomerado hidrófugo revistado de aço inoxidável.

**EN** Agglomerate table top with water repellent protection and stainless steel finish.

**FR** Plateau aggloméré hydrofuge avec revêtement en acier inoxydable.



# Lounge

## **SERIES**

Durban

Berlín

Bali

Tub

Ibiza Daybed

Nana Daybed





NEW

# Durban





## Durban MF-DUR01-010A02

ES Sofá individual. Aluminio lacado blanco. Cojines tejido náutico impermeable.

PT Sofá individual. Alumínio lacado branco. Almofadas tecido náutico impermeável.

EN Single sofa. White lacquered aluminium. Waterproof nautic cushions.

FR Canapé individuel. Aluminium laqué blanc. Coussins tissu nautique imperméable.

A 87 x B 79 x C 77 cm \*



CPF-DUR05P1  
67 x 45 x 10/15 cm



CPF-DUR04P1  
87 x 60 x 15 cm



NEW



## Durban MF-DUR00-010A02

ES Sofá modular. Aluminio lacado blanco. Cojines tejido náutico impermeable.

PT Sofá modular. Alumínio lacado branco. Almofadas tecido náutico impermeável.

EN Modular sofa. White lacquered aluminium. Waterproof nautic cushions.

FR Canapé modulaire. Aluminium laqué blanc. Coussins tissu nautique imperméable.

A 76,5 x B 79 x C 77 cm \*



CPF-DUR03P1  
76 x 45 x 9/15 cm



CPF-DUR02P1  
76 x 59 x 15 cm



## Durban MC-DUR00-010A02

ES Mesa centro reposapiés. Aluminio lacado. Cojines tejido náutico impermeable.

PT Mesa centro repousa-pés. Alumínio lacado branco. Almofadas tecido náutico impermeável.

EN Footrest centre table. White lacquered aluminium. Waterproof nautic cushions.

FR Table centrale repose pieds. Aluminium laqué blanc. Coussins tissu nautique imperméable.

A 86 x B 79 x C 44 cm \*



CPP-DUR01P1  
87 x 73 x 15 cm



NEW



# Berlín MF-BER01-091R50

ES Sofá individual. Aluminio. Ratán antracita 4 vías. Patas acero inox.

PT Sofá individual. Alumínio. Ratan antracita 4 vías. Estrutura das pernas em aço inox.

EN Single sofa. Aluminium. 4 in 1 anthracite rattan. Stainless steel legs.

FR Canapé individuel. Aluminium. Rattan anthracite 4 lignes. Pieds acier Inox.

A 72,5 x B 70,5 x C 83 cm \*



CPF-BERD00011C1 (dralon)  
CPF-BERP07011C1 (nautic)  
54 x 32 x 9/14 cm



CPF-BERD00010C1 (dralon)  
CPF-BERP07010C1 (nautic)  
54 x 62 x 12 cm



# Berlín MF-BER00-091R50

ES Sofá esquinero. Aluminio. Ratán antracita 4 vías. Patas acero inox.

PT Sofá de canto. Alumínio. Ratan antracita 4 vías. Estrutura das pernas em aço inox.

EN Corner sofa. Aluminium. 4 in 1 anthracite rattan. Stainless steel legs.

FR Canapé d'angle. Aluminium. Rattan anthracite 4 lignes. Pieds acier inox.

A 70,5 x B 70,5 x C 83 cm \*



CPF-BERD00001C1 (dralon)  
CPF-BERP07001C1 (nautic)  
62 x 32 x 9/14 cm



CPF-BERD00000C1 (dralon)  
CPF-BERP07000C1 (nautic)  
62 x 62 x 12 cm



\* medida con cojines, medida com almofadas, measure with cushions, mesures avec coussins



## Berlín MF-BER04-091R50

ES Sofá intermedio. Aluminio. Ratán antracita 4 vías. Patas acero inox.

PT Sofá intermédio. Alumínio. Ratan antracita 4 vías. Estrutura das pernas em aço inox.

EN In-between sofa. Aluminium. 4 in 1 anthracite rattan. Stainless steel legs.

FR Canapé intermédiaire. Aluminium. Rattan anthracite 4 lignes. Pieds acier Inox.

A 70,5 x B 70,5 x C 83 cm \*



CPF-BERD00011C1 (dralon)  
CPF-BERP07011C1 (nautic)  
70 x 32 x 9/14 cm



CPF-BERD00010C1 (dralon)  
CPF-BERP07010C1 (nautic)  
70 x 62 x 12 cm

**dralon**  
a step ahead in acrylic fibers



## Berlín MC-BER01-091R50

ES Mesa centro reposapiés. Aluminio. Ratán antracita 4 vías. Patas acero inox. Con cristal.

PT Mesa centro repouso-pés. Alumínio. Ratan antracita 4 vías. Estrutura das pernas em aço inox. Com vidro.

EN Footrest centre table. Aluminium. 4 in 1 anthracite rattan. Stainless steel legs. With glass.

FR Table centrale repose pieds. Aluminium. Rattan anthracite 4 lignes. Pieds acier inox. Avec verre.

A 62,5 x B 70,5 x C 37 cm \*



CPP-BERD00050C1 (dralon)  
CPP-BERP07050C1 (nautic)  
71 x 62 x 12 cm



**dralon**  
a step ahead in acrylic fibers



## Berlín MC-BER00-091R50

ES Mesa Centro. Aluminio. Ratán antracita 4 vías. Patas acero inox. Con cristal.

PT Mesa centro. Alumínio. Ratan antracita 4 vías. Estrutura das pernas em aço inox. Com vidro.

EN Centre table. Aluminium. 4 in 1 anthracite rattan. Stainless steel legs. With glass.

FR Table centrale. Aluminium. Rattan anthracite 4 lignes. Pieds acier Inox. Avec verre.

A 120,5 x B 60,5 x C 42 cm



## Berlín MF-BER01-010R50

ES Sofá individual. Aluminio. Ratán blanco 4 vías. Patas acero inox.

PT Sofá individual. Alumínio. Ratan branco 4 vías. Estrutura das pernas em aço inox.

EN Single sofa. Aluminium. 4 in 1 white rattan. Stainless steel legs.

FR Canapé individuel. Aluminium. Rattan 4 lignes. Pieds acier inox.

A 72,5 x B 70,5 x C 83 cm \*



CPF-BERD00011C1 (dralon)  
CPF-BERP07011C1 (nautic)  
54 x 32 x 9/14 cm



CPF-BERD00010C1 (dralon)  
CPF-BERP07010C1 (nautic)  
54 x 62 x 12 cm

**dralon**  
a step ahead in acrylic fibers

**NAUTIC**  
WATERPROOF



## Berlín MF-BER00-010R50

ES Sofá esquinero. Aluminio. Ratán blanco 4 vías. Patas acero inox.

PT Sofá de canto. Alumínio. Ratan branco 4 vías. Estrutura das pernas em aço inox.

EN Corner sofa. Aluminium. 4 in 1 white rattan. Stainless steel legs.

FR Canapé d'angle. Aluminium. Rattan 4 lignes. Pieds acier inox.

A 70,5 x B 70,5 x C 83 cm \*



CPF-BERD00001C1 (dralon)  
CPF-BERP07001C1 (nautic)  
62 x 32 x 9/14 cm



CPF-BERD00000C1 (dralon)  
CPF-BERP07000C1 (nautic)  
62 x 62 x 12 cm

**dralon**  
a step ahead in acrylic fibers

**NAUTIC**  
WATERPROOF



## Berlín MF-BER04-010R50

ES Sofá intermedio. Aluminio. Ratán blanco 4 vías. Patas acero inox.

PT Sofá intermédio. Alumínio. Ratan branco 4 vias. Estrutura das pernas em aço inox.

EN In-between sofa. Aluminium. 4 in 1 white rattan. Stainless steel legs.

FR Canapé intermédiaire. Aluminium. Rattan 4 lignes. Pieds acier inox.

A 70,5 x B 70,5 x C 83 cm \*



CPF-BERD00011C1 (dralon)  
CPF-BERP07011C1 (nautic)  
70 x 32 x 9/14 cm



CPF-BERD00010C1 (dralon)  
CPF-BERP07010C1 (nautic)  
70 x 62 x 12 cm

**dralon**  
a step ahead in acrylic fibers



## Berlín MC-BER01-010R50

ES Mesa centro reposapiés. Aluminio. Ratán blanco 4 vías. Patas acero inox. Con cristal.

PT Mesa centro repousa-pés. Alumínio. Ratan branco 4 vias. Estrutura das pernas em aço inox. Com vidro.

EN Footrest centre table. Aluminium. 4 in 1 white rattan. Stainless steel legs. With glass.

FR Table centrale repose pieds. Aluminium. Rattan blanc 4 lignes. Pieds acier inox. Avec verre.

A 62,5 x B 70,5 x C 37 cm \*



CPP-BERD00050C1 (dralon)  
CPP-BERP07050C1 (nautic)  
71 x 62 x 12 cm



**dralon**  
a step ahead in acrylic fibers



## Berlín MC-BER00-010R50

ES Mesa Centro. Aluminio. Ratán blanco 4 vías. Patas acero inox. Con cristal.

PT Mesa centro. Alumínio. Ratan branco 4 vias. Estrutura das pernas em aço inox. Com vidro.

EN Centre table. Aluminium. 4 in 1 white rattan. Stainless steel legs. With glass.

FR Table centrale. Aluminium. Rattan blanc 4 lignes. Pieds acier Inox. Avec verre.

A 120,5 x B 60,5 x C 42 cm



# Bali

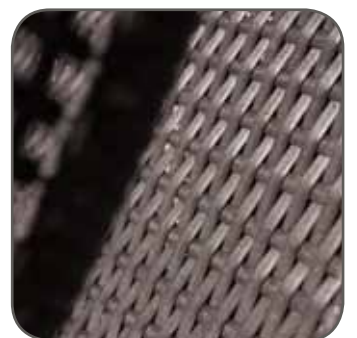

## Bali MF-BAL00-023R31

ES Sofá esquinero. Aluminio. Ratán plano rústico marrón.

PT Sofá de canto. Alumínio. Ratan plano rústico castanho.

EN Corner sofa. Aluminium. Flat rustic brown rattan.

FR Canapé d'angle. Aluminium. Rattan plat rustique marron.

A 90 x B 90 x C 85 cm \*

 CPF-BALD00111P1  
75 x 43 x 9 cm

 CPF-BALD00110P1  
75 x 75 x 16 cm



**dralon**<sup>®</sup>  
a step ahead in acrylic fibers



## Bali MF-BAL01-023R31

ES Sofá intermedio. Aluminio. Ratán plano rústico marrón.

PT Sofá intermédio. Alumínio. Ratan plano rústico castanho.

EN In-between sofa. Aluminium. Flat rustic brown rattan.

FR Canapé intermédiaire. Aluminium. Rattan plat rustique marron.

A 70 x B 90 x C 85 cm \*

 CPF-BALD00011P1  
70 x 43 x 9 cm

 CPF-BALD00010P1  
70 x 73 x 16 cm



**dralon**<sup>®</sup>  
a step ahead in acrylic fibers



## Bali MC-BAL00-023R31

ES Mesa centro reposapiés. Aluminio. Ratán plano rústico marrón. Con cristal.

PT Mesa centro repousa-pés. Alumínio. Ratan plano rústico castanho. Com vidro.

EN Footrest centre table. Aluminium. Flat rustic brown rattan. With glass.

FR Table centrale repose pieds. Aluminium. Rattan plat rustique marron. Avec verre.

A 90 x B 70 x C 48,5 cm \*

 CPP-BALD00000P1  
70 x 90 x 16 cm



**dralon**<sup>®</sup>  
a step ahead in acrylic fibers



# Tub





## Tub MF-TUB00-010R50

ES Sofá apilable individual. Aluminio. Ratán blanco 4 vías.

PT Sofá empilhável individual. Alumínio. Ratan branco 4 vías.

EN Stackable single sofa. Aluminium. 4 in 1 white rattan.

FR Fauteuil empilable individuel. Aluminium. Rattan 4 lignes.

A 61 x B 70 x C 76 cm

colores / cores / colours / couleurs

blanco/branco/white/blanc  
010R50

negro/preto/black/noir  
090R50



CPF-TUBD00010P1  
49 x 49 x 5 cm

 dralon®  
a step ahead in acrylic fibers



## Tub MF-TUB01-010R50

ES Sofá apilable doble. Aluminio. Ratán blanco 4 vías.

PT Sofá empilhável duplo. Alumínio. Ratan branco 4 vías.

EN Stackable double sofa. Aluminium. 4 in 1 white rattan.

FR Fauteuil empilable double. Aluminium. Rattan 4 lignes.

A 121 x B 70 x C 76 cm

colores / cores / colours / couleurs

blanco/branco/white/blanc  
010R50

negro/preto/black/noir  
090R50



CPF-TUBD00020P1  
110 x 47 x 5 cm

 dralon®  
a step ahead in acrylic fibers



## Tub MC-TUB00-010R50

ES Mesa centro. Aluminio. Ratán blanco 4 vías. Con cristal.

PT Mesa centro. Alumínio. Ratan branco 4 vías. Com vidro.

EN Centre table. Aluminium. 4 in 1 white rattan. With glass.

FR Table centrale. Aluminium. Rattan 4 lignes. Avec verre.

A 89 x B 50 x C 40 cm

colores / cores / colours / couleurs

blanco/branco/white/blanc  
010R50

negro/preto/black/noir  
090R50



# Ibiza Daybed - Nana Daybed

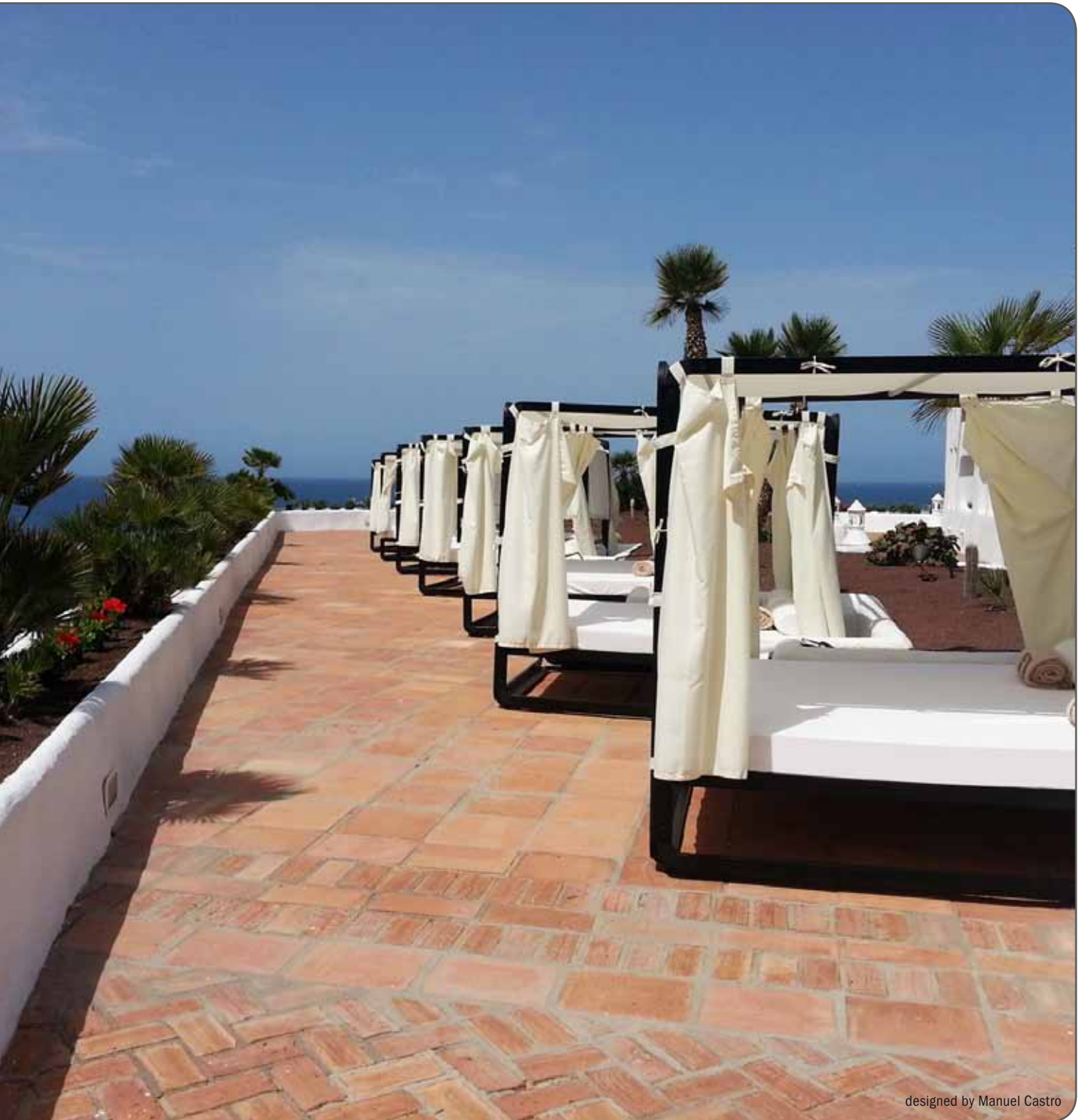

designed by Manuel Castro



## Ibiza Daybed

MQ-IBI00D00140X200  
MQ-IBI00D00180X200

- ES** Daybed estructura aluminio lacado. Tornillería acero inox lacada negro. Conexiones en poliamida con fibra de vidrio. Tejido Dralon. Cojín tejido Nautic.
- PT** Daybed estrutura alumínio lacado. Parafusos aço inox lacada preto. Conexões em poliamida com fibra de vidro. Tecido Dralon. Almofadas tecido náutico.
- EN** Lacquered aluminium structure daybed. Black lacquered stainless steel screws. Polyamide with fiberglass connecting piece. Dralon fabric. Nautic cushions.
- FR** Daybed structure aluminium laqué. Visserie acier inox laqué noir. Connexions en polyamide avec fibre de verre. Tissu Dralon. Coussins tissu nautique.

A 146 x B 206 x C 143 cm

A 186 x B 206 x C 143 cm

colores tejido / cores tecido / fabric colours / couleurs tissu

crudo/cru/ecru/écru  
817

gris/cinza/grey/gris  
853

taupe  
807

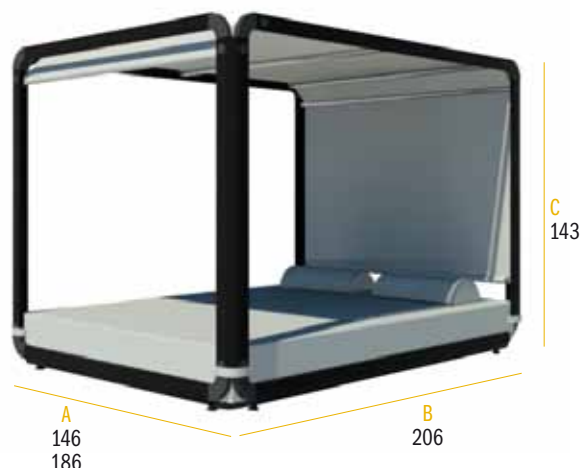

## Ibiza Alto Daybed

MQ-IBIA00D00180X200

- ES** Daybed estructura aluminio lacado. Tornillería acero inox lacada negro. Conexiones en poliamida con fibra de vidrio. Tejido Dralon. Cojín tejido Nautic.
- PT** Daybed estrutura alumínio lacado. Parafusos aço inox lacada preto. Conexões em poliamida com fibra de vidro. Tecido Dralon. Almofadas tecido náutico.
- EN** Lacquered aluminium structure daybed. Black lacquered stainless steel screws. Polyamide with fiberglass connecting piece. Dralon fabric. Nautic cushions.
- FR** Daybed structure aluminium laqué. Visserie acier inox laqué noir. Connexions en polyamide avec fibre de verre. Tissu Dralon. Coussins tissu nautique.

A 190 x B 206 x C 195 cm

colores tejido / cores tecido / fabric colours / couleurs tissu

crudo/cru/ecru/écru  
817

gris/cinza/grey/gris  
853

taupe  
807



## Nana Daybed

MQ-NAN00140X200  
MQ-NAN00180X200

- ES** Daybed estructura aluminio lacado. Tornillería acero inox lacada negro. Conexiones en poliamida con fibra de vidrio. Cojín tejido Nautic.
- PT** Daybed estrutura alumínio lacado. Parafusos aço inox lacada preto. Conexões em poliamida com fibra de vidro. Almofadas tecido náutico.
- EN** Lacquered aluminium structure daybed. Black lacquered stainless steel screws. Polyamide with fiberglass connecting piece. Nautic cushions.
- FR** Daybed structure aluminium laqué. Visserie acier inox laqué noir. Connexions en polyamide avec fibre de verre. Coussins tissu nautique.

A 146 x B 206 x C 58 cm

A 186 x B 206 x C 58 cm

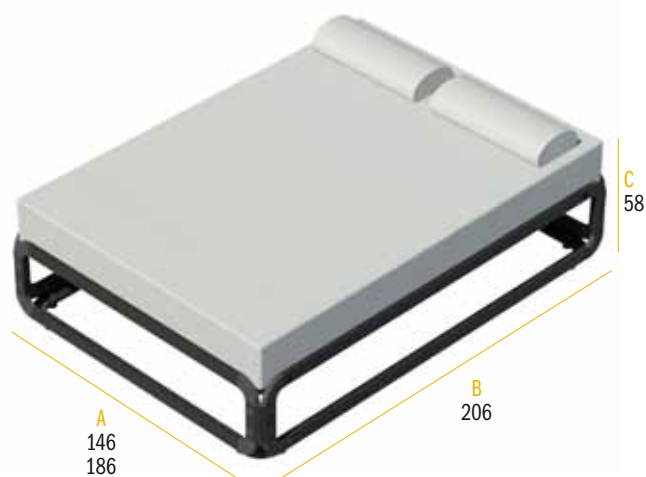

# Sunlounger

## **SERIES**

Spa  
Algarve  
Mónaco  
Forest  
Aqua  
Nautic





# Spa - Algarve

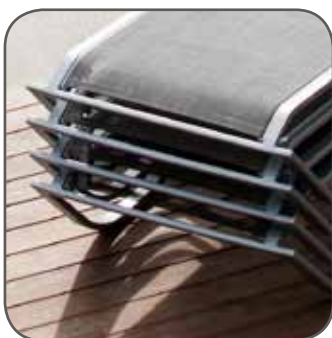
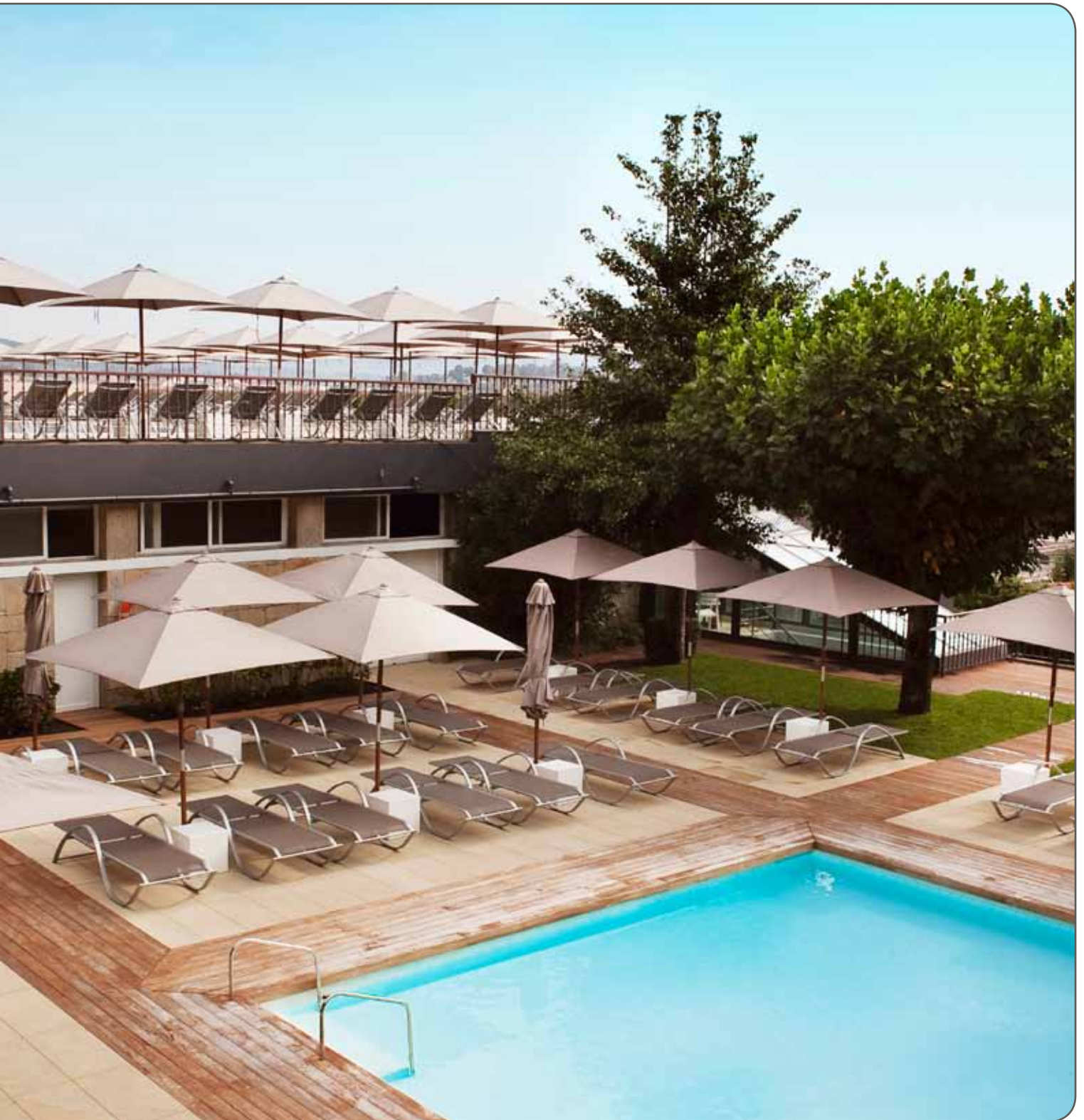

## Spa MU-SPA00

ES Tumbona apilable 5 posiciones. Aluminio lacado gris. Batyline.

PT Espreguiçadeira empilhável 5 posições. Alumínio lacado cinza. Batyline.

EN 5 positions stackable sunlounger. Grey lacquered aluminium. Batyline.

FR Bain de soleil empilable 5 positions. Aluminium laqué gris. Batyline.

A 74 x B 198 x C 70/102 x D 34 cm

cores / cores / colours / couleurs

taupe  
020T30

beige/bege  
070T30

negro/preto/black/noir  
090T30



BATYLINE



## Algarve MU-ALG00-020T21

ES Tumbona apilable 5 posiciones. Aluminio pintado taupe. Textilene taupe 2x2.

PT Espreguiçadeira empilhável 5 posições. Alumínio pintado taupe. Textilene taupe 2x2.

EN 5 positions stackable sunlounger. Taupe painted aluminium. Taupe 2x2 Textilene.

FR Bain de soleil empilable 5 positions. Aluminium peint taupe. Textilene taupe 2x2.

A 70 x B 198 x C 77/98 x D 34 cm

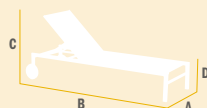

# Mónaco - Forest





## Mónaco MU-MON00-001T21

ES Tumbona con ruedas 5 posiciones. Aluminio pintado gris. Textilene 2x2.

PT Espreguiçadeira com rodas 5 posições. Alumínio pintado cinza. Textilene 2x2.

EN 5 positions sunlounger with wheels. Gray painted aluminium. 2x2 Textilene.

FR Bain de soleil avec roues 5 positions. Aluminium peint gris. Textilene 2x2.

A 67 x B 197 x C 65/105 x D 35 cm

colores / cores / colours / couleurs

beige/bege/beige  
001T21

gris/cinza/gray/gris  
030T21

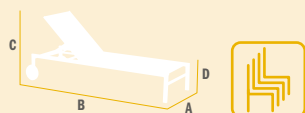

## Mónaco 42MON90/42MON92 45X45 42MON93/42MON94

ES Mesa apilable. Pata de aluminio en gris/blanco/óxido/negro

PT Mesa empilhável. Alumínio. Pé de alumínio cor cinza/branco/óxido/preto.

EN Stackable table. Legs in grey/white/rust/black painted aluminium.

FR Table empilable. Pieds aluminium gris/blanc/rouille/noire.

A 45 x B 45 x C 45 cm

colores / cores / colours / couleurs

gris/cinza/gray/gris  
42MON90

negro/preto/black/noire  
42MON92

óxido/rust/rouille  
42MON93

blanco/branco/white/blanc  
42MON94

COMPACT



## Forest MG-SOLD0000

ES Hamaca plegable 3 posiciones. Balau amarillo. Anclaje de seguridad. Tejido Dralon.

PT Espreguiçadeira dobrável 3 posições. Balau amarelo. Fixação de segurança. Tecido Dralon.

EN 3 positions folding deck chair. Yellow balau. Security fixing. Dralon fabric.

FR Chienne pliante 3 positions. Balau jaune. Fixation de sécurité. Tissu Dralon.

A 60 x B 83 x C 125



dralon®  
a step ahead in acrylic fibers

Tejido extraíble y lavable  
Tecido extraível e lavável  
Removable and washable fabric  
Tissu retirable et lavable



# Aqua y Nautic

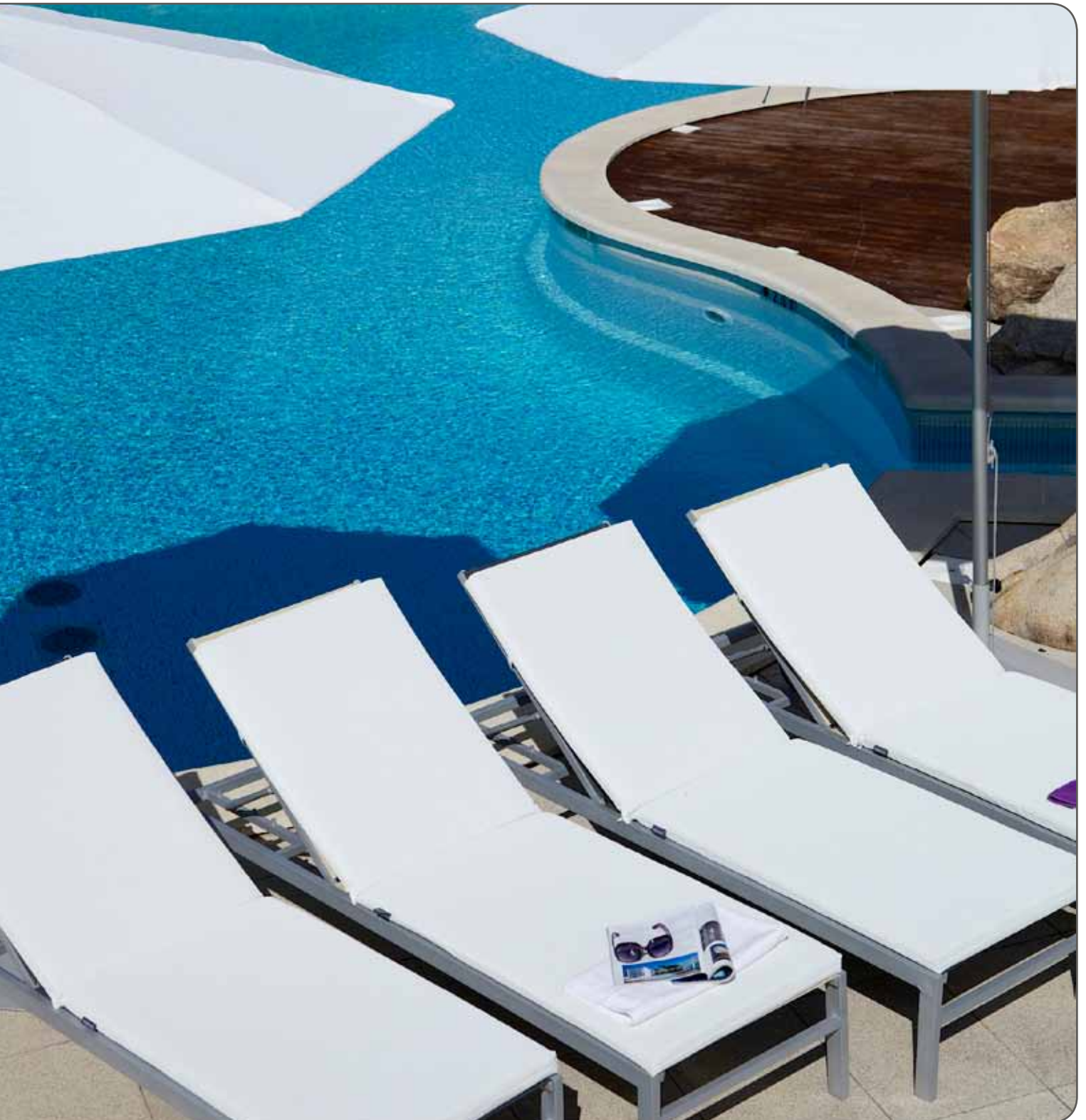

## Aqua 913-T003

ES Cojín asiento AQUA. Textilene. Permeable al agua.

PT Almofada assento AQUA. Textilene. Permeável à água.

EN AQUA Seat Cushion. Textilene. Water permeable.

FR Coussin siège AQUA. Textilene. Perméable à l'eau.

45 x 45 x 6 cm

colores / cores / colours / couleurs



## Aqua 681-T001

ES Cojín tumbona AQUA. Textilene. Permeable al agua.

PT Almofada espreguiçadeira AQUA. Textilene. Permeável à água.

EN AQUA Sunlounger Cushion. Textilene. Water permeable.

FR Coussin Bain de soleil AQUA. Textilene. Perméable à l'eau.

60 x 190 (80+110) x 6 cm

colores / cores / colours / couleurs

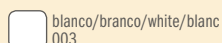
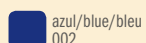

## Nautic 681-NA010

ES Cojín tumbona NAUTIC. Tejido náutico. Impermeable.

PT Almofada espreguiçadeira NAUTIC. Tecido náutico. Impermeável.

EN NAUTIC Sunlounger Cushion. Nautic fabric. Waterproof.

FR Coussin Bain de soleil NAUTIC. Tissu nautic. Imperméable.

60 x 190 (80+110) x 6 cm

colores / cores / colours / couleurs

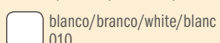

# Parasol

## **SERIES**

Ibiza Pergola

Nova Pergola

Moka Pergola

Flexo

Ipanema

Río

Creta

Malta

Vigo

Formentera

Bahamas

Tenerife

Java

Palloza





# Ibiza - Nova - Moka



# Ibiza

285X285 MY-IBI00D00300X300  
 285X400 MY-IBI00D00300X400  
 285X500 MY-IBI00D00300X500

**ES** Aluminio lacado. Tornillería acero inox lacada negro. Conexiones en poliamida con fibra de vidrio. Tejido Dralon.

**PT** Alumínio lacado. Parafusos aço Inox lacada preto. Conexões em poliamida com fibra de vidro. Tecido Dralon.

**EN** Laquered aluminium. Black lacquered stainless steel screws. Polyamide with fiberglass connecting piece. Dralon fabric.

**FR** Aluminium laqué. Visserie acier Inox laqué noir. Connexions en polyamide avec fibre de verre. Tissu Dralon.

A 285 x B 285/400/500 x C 220 cm

colores tejido / cores tecido / fabric colours / couleurs tissu

crudo/cru/ecru/écru 817    gris/cinza/grey/gris 853    taupe 807

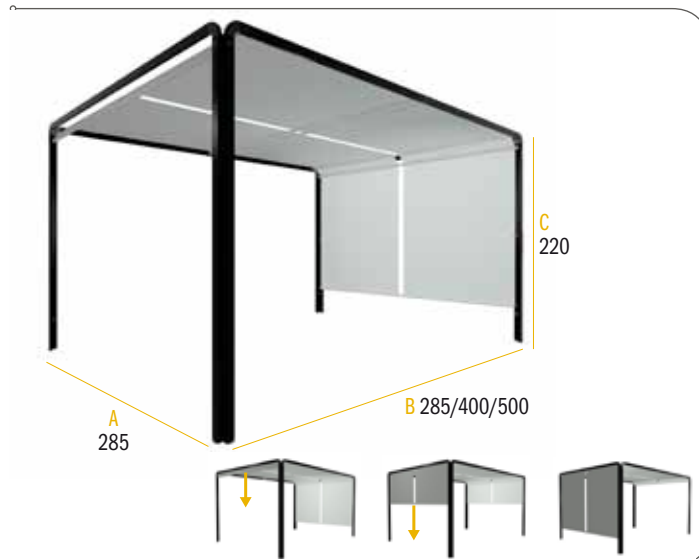

# Nova

285X285 MY-NOV00D00300X300  
 285X400 MY-NOV00D00300X400  
 285X500 MY-NOV00D00300X500

**ES** Aluminio lacado. Tornillería acero inox lacada negro. Conexiones en poliamida con fibra de vidrio. Tejido Dralon.

**PT** Alumínio lacado. Parafusos aço Inox lacada preto. Conexões em poliamida com fibra de vidro. Tecido Dralon.

**EN** Laquered aluminium. Black lacquered stainless steel screws. Polyamide with fiberglass connecting piece. Dralon fabric.

**FR** Aluminium laqué. Visserie acier Inox laqué noir. Connexions en polyamide avec fibre de verre. Tissu Dralon.

A 285 x B 285/400/500 x C 220 cm

colores tejido / cores tecido / fabric colours / couleurs tissu

crudo/cru/ecru/écru 817    gris/cinza/grey/gris 853    taupe 807

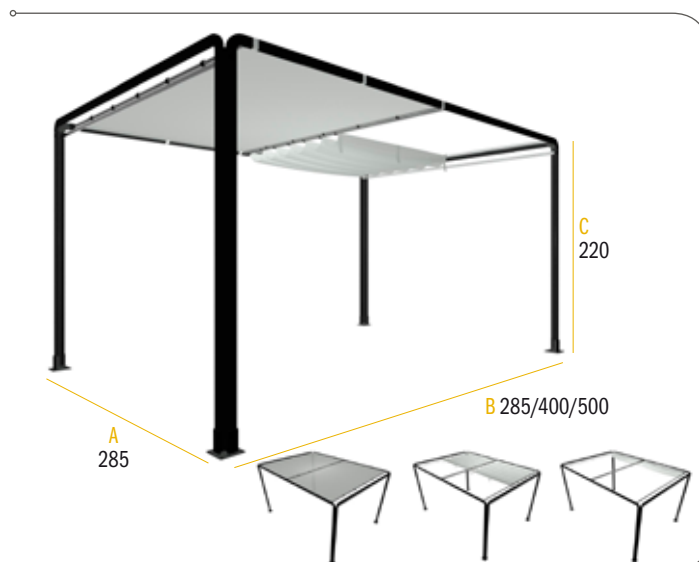

# Moka

285X285 MY-MOK00D00300X300  
 285X400 MY-MOK00D00300X400  
 285X500 MY-MOK00D00300X500

**ES** Aluminio lacado. Tornillería acero inox lacada negro. Conexiones en poliamida con fibra de vidrio. Tejido Dralon.

**PT** Alumínio lacado. Parafusos aço Inox lacada preto. Conexões em poliamida com fibra de vidro. Tecido Dralon.

**EN** Laquered aluminium. Black lacquered stainless steel screws. Polyamide with fiberglass connecting piece. Dralon fabric.

**FR** Aluminium laqué. Visserie acier Inox laqué noir. Connexions en polyamide avec fibre de verre. Tissu Dralon.

A 285 x B 285/400/500 x C 220 cm

colores tejido / cores tecido / fabric colours / couleurs tissu

crudo/cru/ecru/écru 817    gris/cinza/grey/gris 853    taupe 807

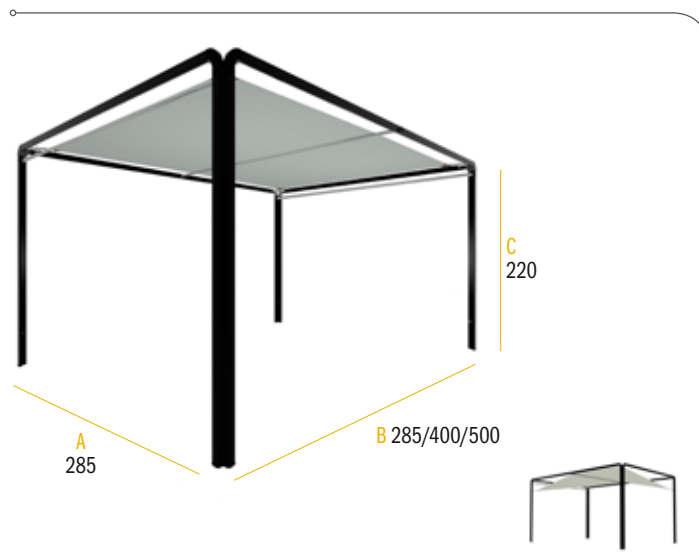

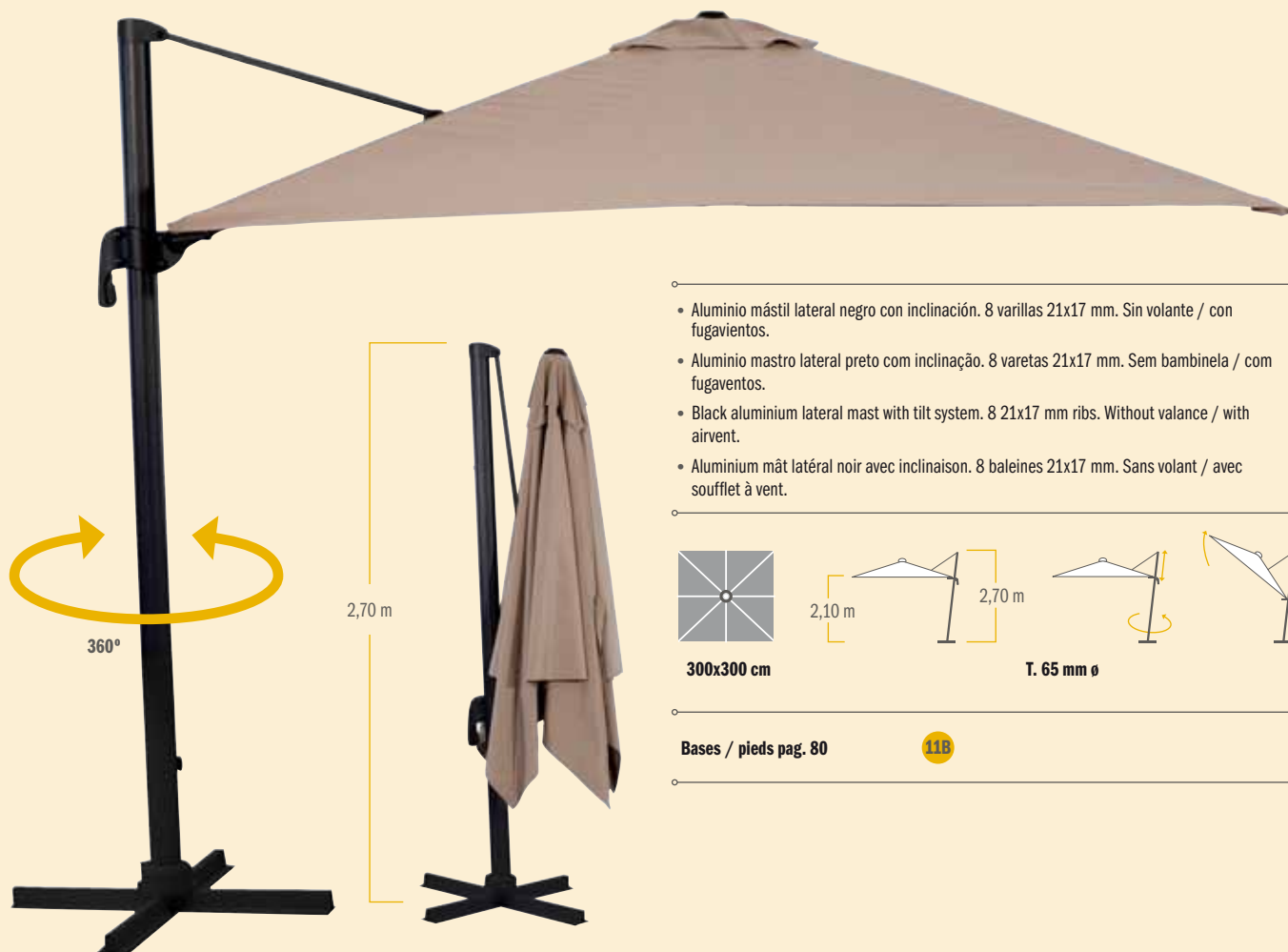

- Aluminio mástil lateral negro con inclinación. 8 varillas 21x17 mm. Sin volante / con fugavientos.
- Aluminio mastro lateral preto com inclinação. 8 varetas 21x17 mm. Sem bambinela / com fugaventos.
- Black aluminium lateral mast with tilt system. 8 21x17 mm ribs. Without valance / with airvent.
- Aluminium mât latéral noir avec inclinaison. 8 baleines 21x17 mm. Sans volant / avec soufflet à vent.

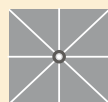

300x300 cm

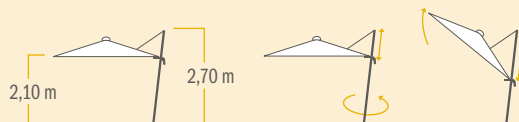

T. 65 mm ø

Bases / pieds pag. 80

118

Colores tejido / cores tecido / fabric colours / couleurs tissu - Dralon®





# Flexo

SGAP09C3005021P (Polyester 100%) - SGAP11C3005021P (Polyester-Waterproof)  
SGAD00C3005021P (Dralon)

300x300/8-2

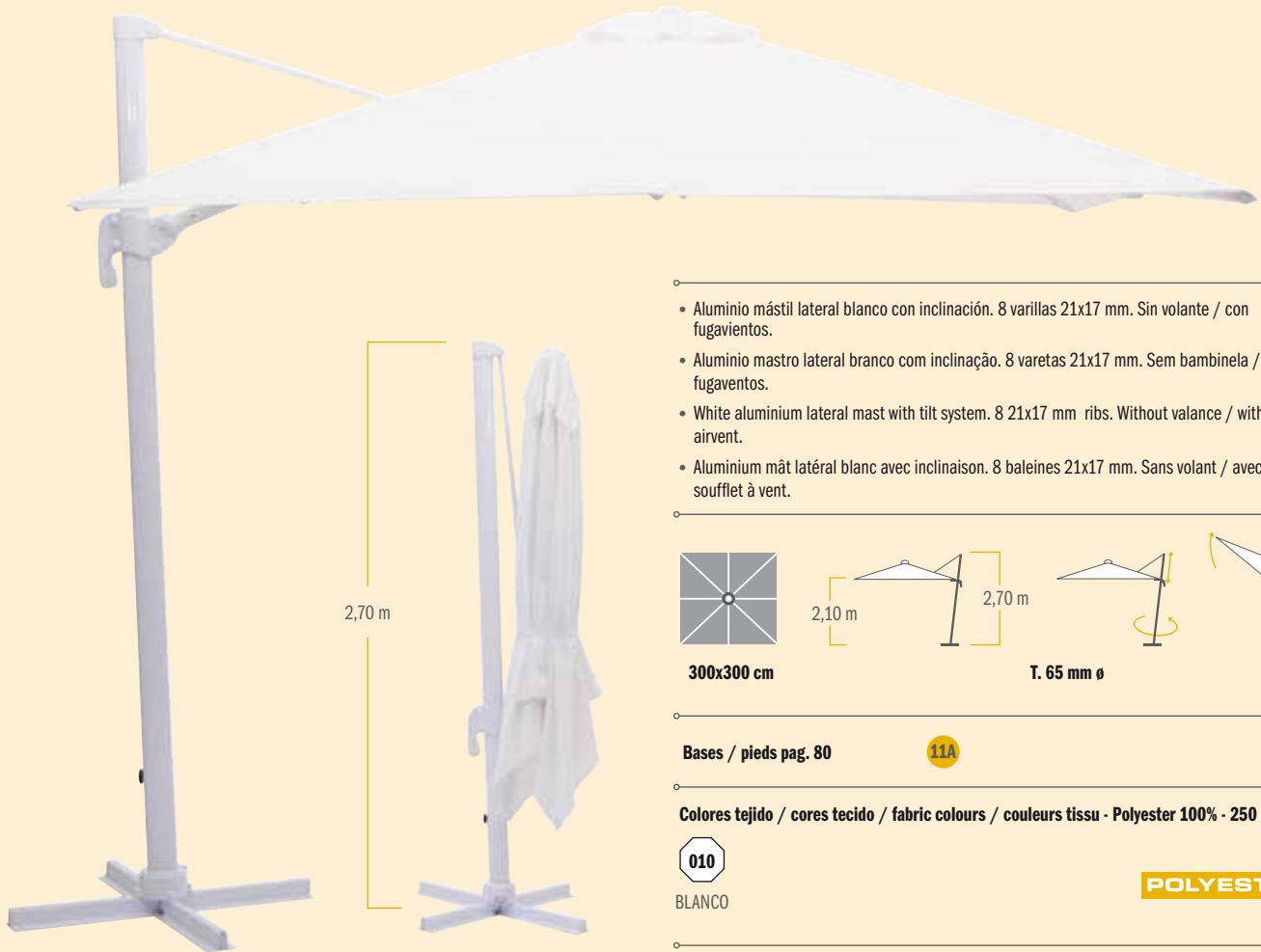

- Aluminio mástil lateral blanco con inclinación. 8 varillas 21x17 mm. Sin volante / con fugavientos.
- Aluminio mastro lateral branco com inclinação. 8 varetas 21x17 mm. Sem bambinela / com fugaventos.
- White aluminium lateral mast with tilt system. 8 21x17 mm ribs. Without valance / with airvent.
- Aluminium mât latéral blanc avec inclinaison. 8 baleines 21x17 mm. Sans volant / avec soufflet à vent.

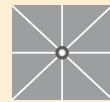

300x300 cm

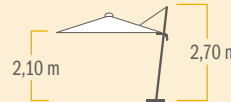

T. 65 mm ø

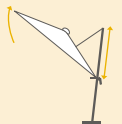

Bases / pieds pag. 80

11A

Colores tejido / cores tecido / fabric colours / couleurs tissu - Polyester 100% - 250 gr

010

BLANCO

POLYESTER

 dralon®  
a step ahead in acrylic fibers

 made in  
Green®  
by AITEX



Colores tejido / cores tecido / fabric colours / couleurs tissu - Polyester-Waterproof

010

BLANCO

 POLYESTER  
WATERPROOF



# Ipanema

SGAD50C3300040P (Acrílico) - SGAP11C3300040P (Polyester-Waterproof)

330x330/8-4

- Aluminio gris. 8 varillas 20x26x1 mm. Con volante / con fugavientos. Apertura "Easy-Track".
- Aluminio cinza. 8 varetas 20x26x1 mm. Com bambinela / com fugaventos. Abertura "Easy-Track".
- Grey aluminium. 8 20x26x1 mm ribs. With valance / with airvent. "Easy-Track" opening system.
- Aluminium gris. 8 baleines 20x26x1 mm. Avec volant / avec soufflet à vent. Ouverture "Easy-Track".

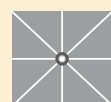

2,80 m



2,16 m

T. 65/65 mm ø

Bases / pieds pag. 80

330x330 cm

12

7 T.70

10 T.70

14 T.70

Colores tejido / cores tecido / fabric colours / couleurs tissu - Acrílico 100% - 300 gr Teflón

I16

I14

I25

I17

BURDEOS

AZUL

VERDE

CRUDO

Colores tejido / cores tecido / fabric colours / couleurs tissu - Polyester-Waterproof

010

BLANCO

ACRYLIC

POLYESTER  
IMPERMEABLE



# Ipanema

SGAD5003500240P (Acrílico) - SGAP1103500240P (Polyester-Waterproof)

Ø350/8-4

- Aluminio gris. 8 varillas 20x26x1 mm. Con volante / con fugavientos. Apertura "Easy-Track".
- Aluminio cinza. 8 varetas 20x26x1 mm. Com bambinela / com fugaventos. Abertura "Easy-Track".
- Grey aluminium. 8 20x26x1 mm ribs. With valance / with airvent. "Easy-Track" opening system.
- Aluminium gris. 8 baleines 20x26x1 mm. Avec volant / avec soufflet à vent. Ouverture "Easy-Track".



Ø 350 cm

2,90 m



2,12 m

T. 65/65 mm Ø

Bases / pieds pag. 80

12

7 T.70

10 T.70

14 T.70

Colores tejido / cores tecido / fabric colours / couleurs tissu - Acrílico 100% - 300 gr Teflón

I16

I14

I25

I17

BURDEOS

AZUL

VERDE

CRUDO

Colores tejido / cores tecido / fabric colours / couleurs tissu - Polyester-Waterproof

010

BLANCO

ACRYLIC

POLYESTER  
IMPERMEABLE



**400x400/8-4**

- Aluminio gris. 8 varillas 20x35x1,5 mm. Con volante / con fugavientos. Apertura asistida manivela.
- Aluminio cinza. 8 varetas 20x35x1,5 mm. Com bambinela / com fugaventos. Abertura assistida manivela.
- Grey aluminium. 8 20x35x1,5 mm ribs. With valance / with airvent. Crank-assisted opening system.
- Aluminium gris. 8 baleines 20x35x1,5 mm. Avec volant / avec soufflet à vent. Ouverture assistée manivela.

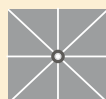

400x400 cm



T. 71x71 mm

Bases / pieds pag. 80

13 7 T.63,5 10 T.85 14 T.85

Colores tejido / cores tecido / fabric colours / couleurs tissu - Acrílico 100% - 300 gr Teflón



Colores tejido / cores tecido / fabric colours / couleurs tissu - Polyester-Waterproof



**ACRYLIC**



Ø 500/8-4

- Aluminio gris. 8 varillas 20x35x1,5 mm. Con volante / con fugavientos. Apertura asistida manivela.
- Aluminio cinza. 8 varetas 20x35x1,5 mm. Com bambinela / com fugaventos. Abertura assistida manivela.
- Grey aluminium. 8 20x35x1,5 mm ribs. With valance / with airvent. Crank-assisted opening system.
- Aluminium gris. 8 baleines 20x35x1,5 mm. Avec volant / avec soufflet à vent. Ouverture assistée manivelle.



Ø 500 cm



T. 71x71 mm

Bases / pieds pag. 80

13 T.63,5 10 T.85 14 T.85

Colores tejido / cores tecido / fabric colours / couleurs tissu - Acrílico 100% - 300 gr Teflón

116

114

125

117

BURDEOS

AZUL

VERDE

CRUDO

Colores tejido / cores tecido / fabric colours / couleurs tissu - Polyester-Waterproof

010

BLANCO

**ACRYLIC**

**POLYESTER**  
IMPERMEABLE



# Creta

SPAD00D2005110P (Dralon)  
SPAP11D2005110P (Polyester-Waterproof)

∅ 200/10-1



- Aluminio anodizado con inclinación. 10 varillas 5 mm. Con volante / sin fugavientos.
- Alumínio anodizado com inclinação. 10 varetas 5 mm. Com bambinela / sem fugaventos.
- Anodized aluminium with tilt system. 10 5 mm ribs. With valance / without airvent.
- Aluminium anodisé avec inclinaison. 10 baleines 5 mm. Avec volant / sans soufflet à vent.

1

5A1

5C1



∅ 200 cm



2,54 m

2,02 m

T. 28/32 mm ∅

Inclinación inox. Inclinação inox. Inox tilt system. Inclinaison inox.

# Creta

SPAD00D2005100P (Dralon)  
SPAP11D2005100P (Polyester-Waterproof)

∅ 200/10-0



- Aluminio anodizado con inclinación. 10 varillas 5 mm. Sin volante / sin fugavientos.
- Alumínio anodizado com inclinação. 10 varetas 5 mm. Sem fugaventos.
- Anodized aluminium with tilt system. 10 5 mm ribs. Dralon Without valance / without airvent.
- Aluminium anodisé avec inclinaison. 10 baleines 5 mm. Sans volant / sans soufflet à vent.

1

5A1

5C1



∅ 200 cm



2,54 m

2,14 m

T. 28/32 mm ∅

Inclinación inox. Inclinação inox. Inox tilt system. Inclinaison inox.

# Malta.2

SPAD00C200041P (Dralon)  
SPAP11C200041P (Polyester-Waterproof)

200x200/4-4



- Aluminio anodizado. 4 varillas 19x13 mm. Con volante / sin fugavientos.
- Alumínio anodizado. 4 varetas 19x13 mm. Com bambinela / sem fugaventos.
- Anodized aluminium. 4 19x13 mm ribs. With valance / without airvent.
- Aluminium anodisé. 4 baleines 19x13 mm. Avec volant / sans soufflet à vent.

5A1

5C1



200x200 cm



2,43 m

1,88 m

T. 32/32 mm ∅

Apertura Push-Up. Abertura Push-Up. Push-Up opening system. Ouverture Push-Up

# Malta.2

SPAD00C200021P (Dralon)  
SPAP11C200021P (Polyester-Waterproof)

200x200/4-2



- Aluminio anodizado. 4 varillas 19x13 mm. Sin volante / con fugavientos.
- Alumínio anodizado. 4 varetas 19x13 mm. Sem bambinela / com fugaventos.
- Anodized aluminium. 4 19x13 mm ribs. Without valance / with airvent.
- Aluminium anodisé. 4 baleines 19x13 mm. Sans volant / avec soufflet à vent.

5A1

5C1



200x200 cm



2,43 m

2 m

T. 32/32 mm ∅

Apertura Push-Up. Abertura Push-Up. Push-Up opening system. Ouverture Push-Up

## Colores tejido / cores tecido / fabric colours / couleurs tissu - Dralon

806

CREMA

807

TAUPE

814

AMARILLO

816

BURDEOS

817

CRUDO

824

AZUL

825

VERDE

836

CHOCOLATE

853

GRIS

886

VERDE H

835

NEGRO

844

BLANCO

**dralon**  
a step ahead in acrylic fibers

**made in Green**  
by AITEX  
N° 08AN5791

40

P



Creta



Malta



Malta



1  
Volante sin fugavientos  
Bambinela sem fugaventos  
Valance without airvent  
Volant sans soufflet



4  
Con volante con fugavientos  
Bambinela com fugaventos  
Valance with airvent  
Volant avec soufflet



2  
Sin volante con fugavientos  
Sem bambinela com fugaventos  
Without valance with airvent  
Sans volant avec soufflet



0  
Sin volante sin fugavientos  
Sem bambinela sem fugaventos  
Without valance without airvent  
Sans volant sans soufflet

# Vigo

SIAD00C2500040P (Dralon)  
SIAP11C2500040P (Polyester-Waterproof)

250x250/8-4



- Aluminio anodizado. 8 varillas 22x12 mm. Con volante / sin fugavientos.
- Aluminio anodizado. 8 varetas 22x12 mm. Com bambinela / sem fugavientos.
- Anodized aluminium. 8 22x12 mm ribs. With valance / without airvent.
- Aluminium anodisé sans inclinaison. 8 baleines 22x12 mm. Avec volant / sans soufflet. à vent.

- 2A1 8
- 2C1 7 T.55
- 4A2 10 T.55
- 4C2 14 T.55

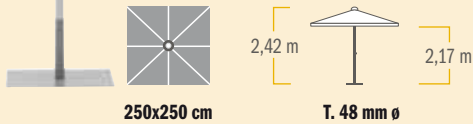

Apertura por poleas. Abertura por roldanas. Pulley opening system. Ouverture pour poulie

# Vigo

SIAD00C2500020P (Dralon)  
SIAP11C2500020P (Polyester-Waterproof)

250x250/8-2



- Aluminio anodizado. 8 varillas 22x12 mm. Sin volante / con fugavientos.
- Aluminio anodizado. 8 varetas 22x12 mm. Sem bambinela / com fugavientos.
- Anodized aluminium. 8 22x12 mm ribs. Without valance / with airvent.
- Aluminium anodisé. 8 baleines 22x12 mm. Sans volant / avec soufflet à vent.

- 2A1 8
- 2C1 7 T.55
- 4A2 10 T.55
- 4C2 14 T.55

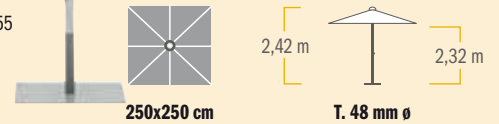

Apertura por poleas. Abertura por roldanas. Pulley opening system. Ouverture pour poulie

# Vigo

SIAD0003000710P (Dralon)  
SIAP1103000710P (Polyester-Waterproof)

∅ 300/8-1



- Aluminio anodizado. 8 varillas 19x13 mm. Con volante / sin fugavientos.
- Aluminio anodizado. 8 varetas 19x13 mm. Com bambinela / sem fugavientos.
- Anodized aluminium. 8 19x13 mm ribs. With valance / without airvent.
- Aluminium anodisé sans inclinaison. 8 baleines 19x13 mm. Avec volant / sans soufflet.

- 2A1 8
- 2C1 7 T.55
- 4A2 10 T.55
- 4C2 14 T.55

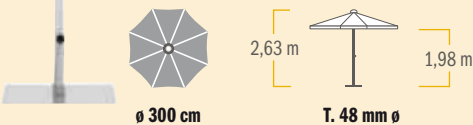

Apertura por poleas. Abertura por roldanas. Pulley opening system. Ouverture pour poulie

# Vigo

SIAD0003000700P (Dralon)  
SIAP1103000700P (Polyester-Waterproof)  
SIAT0103000720P (Aqua)

∅ 300/8-0



- Aluminio anodizado. 8 varillas 19x13 mm. Sin volante / sin fugavientos.
- Aluminio anodizado. 8 varetas 19x13 mm. Sem bambinela / sem fugavientos.
- Anodized aluminium. 8 19x13 mm ribs. Without valance / without airvent.
- Aluminium anodisé. 8 baleines 19x13 mm. Sans volant / sans soufflet à vent.

- 2A1 8
- 2C1 7 T.55
- 4A2 10 T.55
- 4C2 14 T.55

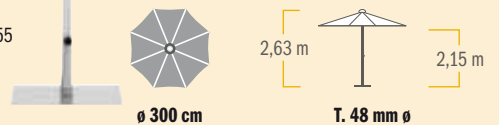

Apertura por poleas. Abertura por roldanas. Pulley opening system. Ouverture pour poulie



Colores tejido / cores tecido / fabric colours / couleurs tissu - Polyester-Waterproof



010

BLANCO

Colores tejido / cores tecido / fabric colours / couleurs tissu - Aqua



001

BEIGE

002

AZUL

003

BLANCO

Bases / pieds pag. 80

000



Vigo



Vigo



Vigo



LEDS SA000

# Vigo

SGAD00H3000040P (Dralon)  
SGAP11H3000040P (Polyester-Waterproof)

## 300x200/6-4



- 2A1 8
- 2C1 7 T.55
- 4A2 10 T.55
- 4C2 14 T.55

- Aluminio anodizado. 6 varillas 19x13 mm. Con volante / sin fugavientos.
- Aluminio anodizado. 6 varetas 19x13 mm. Com bambinela / sem fugaventos.
- Aluminium anodized. 6 19x13 mm ribs. With valance / without airvent.
- Aluminium anodisé. 6 baleines 19x13 mm. Avec volant / sans soufflet à vent.

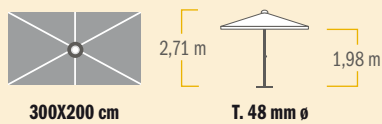

Apertura por poleas. Abertura por roldanas. Pulley opening system. Ouverture pour poulie

# Vigo

SGAD00H3000020P (Dralon)  
SGAP11H3000020P (Polyester-Waterproof)

## 300x200/6-2



- 2A1 8
- 2C1 7 T.55
- 4A2 10 T.55
- 4C2 14 T.55

- Aluminio anodizado. 6 varillas 19x13 mm. Sin volante / con fugavientos.
- Aluminio anodizado. 6 varetas 19x13 mm. Sem bambinela / com fugaventos.
- Anodized aluminium. 6 19x13 mm ribs. Without valance / with airvent.
- Aluminium anodisé sans. 6 baleines 19x13 mm. Sans volant / avec soufflet à vent.

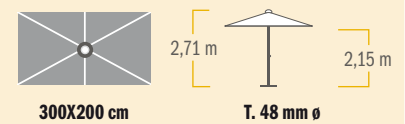

Apertura por poleas. Abertura por roldanas. Pulley opening system. Ouverture pour poulie

# Vigo

SGAD00C3000040P (Dralon)  
SGAP11C3000040P (Polyester-Waterproof)

## 300x300/8-4



- 2A1 8
- 2C1 7 T.55
- 4A2 10 T.55
- 4C2 14 T.55

- Aluminio anodizado. 8 varillas 19x13 mm. Con volante / con fugavientos.
- Aluminio anodizado. 8 varetas 19x13 mm. Com bambinela / com fugaventos.
- Anodized aluminium. 8 19x13 mm ribs. With valance / with airvent.
- Aluminium anodisé. 8 baleines 19x13 mm. Avec volant / avec soufflet à vent.

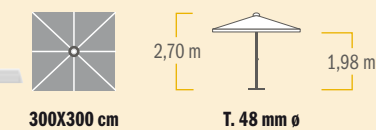

Apertura por poleas. Abertura por roldanas. Pulley opening system. Ouverture pour poulie

# Vigo

SGAD00C3000020P (Dralon)  
SGAP11C3000020P (Polyester-Waterproof)

## 300x300/8-2



- 2A1 8
- 2C1 7 T.55
- 4A2 10 T.55
- 4C2 14 T.55

- Aluminio anodizado. 8 varillas 19x13 mm. Sin volante / con fugavientos.
- Aluminio anodizado. 8 varetas 19x13 mm. Sem bambinela / com fugaventos.
- Anodized aluminium. 8 19x13 mm ribs. Without valance / with airvent.
- Aluminium anodisé. 8 baleines 19x13 mm. Sans volant / avec soufflet à vent.

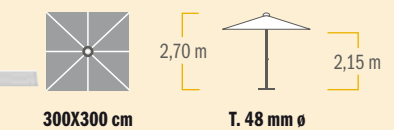

Apertura por poleas. Abertura por roldanas. Pulley opening system. Ouverture pour poulie

### Colores tejido / cores tecido / fabric colours / couleurs tissu - Dralon

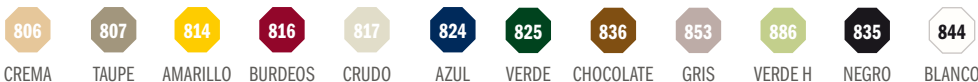



# Formentera

SGAD00C3000240P (Dralon)  
SGAP11C3000240P (Polyester-Waterproof)

300x300/8-4

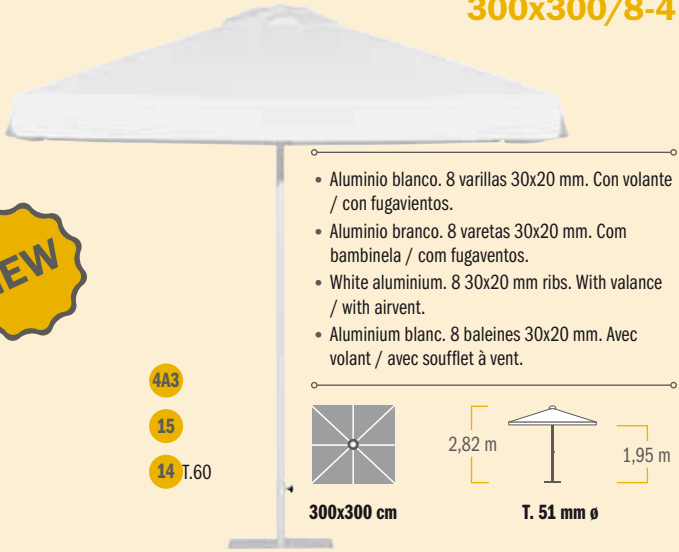

- Aluminio blanco. 8 varillas 30x20 mm. Con volante / con fugavientos.
- Aluminio branco. 8 varetas 30x20 mm. Com bambinela / com fugaventos.
- White aluminium. 8 30x20 mm ribs. With valance / with airvent.
- Aluminium blanc. 8 baleines 30x20 mm. Avec volant / avec soufflet à vent.

4A3

15

14 T.60



300x300 cm



2,82 m



T. 51 mm ø

Apertura por poleas. Abertura por roldanas. Pulley opening system. Ouverture pour poulie

# Formentera

SGAD00C3000220P (Dralon)  
SGAP11C3000220P (Polyester-Waterproof)

300x300/8-2

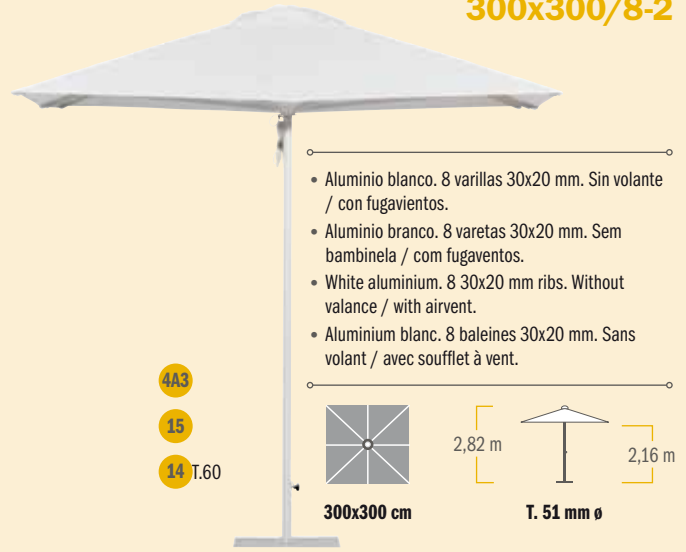

- Aluminio blanco. 8 varillas 30x20 mm. Sin volante / con fugavientos.
- Aluminio branco. 8 varetas 30x20 mm. Sem bambinela / com fugaventos.
- White aluminium. 8 30x20 mm ribs. Without valance / with airvent.
- Aluminium blanc. 8 baleines 30x20 mm. Sans volant / avec soufflet à vent.

4A3

15

14 T.60



300x300 cm



2,82 m



T. 51 mm ø

Apertura por poleas. Abertura por roldanas. Pulley opening system. Ouverture pour poulie

# Bahamas

SGAD00C3700040P (Dralon)  
SGAP11C3700040P (Polyester-Waterproof)

370x370/8-4



- Aluminio anodizado. 8 varillas 20x30 mm. Sin volante / Con fugavientos.
- Aluminio anodizado. 8 varetas 20x30 mm. Sem bambinela / com fugaventos.
- Anodized aluminium. 8 20x30 mm ribs. Without valance / with airvent.
- Aluminium anodisé. 8 baleines 20x30 mm. Sans volant / avec soufflet à vent.

4C3

15

14 T.60



370x370 cm



2,80 m



T. 50 mm ø

Apertura por poleas. Abertura por roldanas. Pulley opening system. Ouverture pour poulie.

# Tenerife

SPID00D2005310P (Dralon)  
SPIT01D2005310P (Aqua)

Ø 200/10-1



- Inox con inclinación. 10 varillas de fibra de vidrio. Con volante / Sin fugavientos.
- Inox com inclinação. 10 varetas de fibra de vidro. Com bambinela / sem fugaventos.
- Inox with tilt system. 10 fiberglass ribs. With valance / without airvent.
- Inox avec inclinaison. 10 baleines en fibre de verre. Avec volant / sans soufflet à vent.

5A1

5C1



ø 200 cm



2,43 m



T. 28/35 mm ø

Inclinación inox. Inclinação inox. Inox tilt system. Inclinaison inox.



Colores tejido / cores tecido / fabric colours / couleurs  
tissu - Polyester-Waterproof

010

BLANCO



Colores tejido / cores tecido / fabric colours / couleurs tissu - Aqua

001

BEIGE

002

AZUL

003

BLANCO



Bases / pieds pag. 80

000



Formentera



Formentera



Formentera



Formentera

# Java

SPMD0002000010P  
SIMD0003000510P  
SGMD0004000040P

Ø 200/8-1  
Ø 300/8-1  
Ø 400/8-4



Ø 200 cm - Ø 300 cm\* - Ø 400 cm



T. 35 mm Ø - T. 48 mm Ø - T. 60 mm Ø

- Madera barnizada color teka. 8 varillas 17x22 mm. Tejido Dralon 200 gr/m<sup>2</sup> con volante / sin fugavientos.
- Madeira vernizada cor teka. 8 varetas 17x22 mm. Tecido Dralon 200 gr/m<sup>2</sup> com babinela / sem fugavientos
- Varnished teak colour wood. 8 17x22 mm ribs. Dralon fabric 200 gr/m<sup>2</sup> with valance / without airvent.
- Bois avec vernis couleur teck. 8 baleines 17x22 mm. Tissu Dralon 220gr/m<sup>2</sup> avec volant / sans soufflet à vent.

5B2 4B2 7 T.55/70  
10 T.55/70 14 T.55/70

Apertura por poleas. Abertura por roldanas. Pulley opening system. Ouverture pour poulie

# Java

SPMD0002000000P  
SIMD0003000500P  
SGMD0004000020P

Ø 200/8-0  
Ø 300/8-0  
Ø 400/8-2



Ø 200 cm - Ø 300 cm\* - Ø 400 cm



T. 35 mm Ø - T. 48 mm Ø - T. 60 mm Ø

- Madera barnizada color teka. 8 varillas 17x22 mm. Tejido Dralon 200 gr/m<sup>2</sup> sin volante / sin fugavientos.
- Madeira vernizada cor teka. 8 varetas 17x22 mm. Tecido Dralon 200 gr/m<sup>2</sup> sem babinela / sem fugavientos
- Varnished teak colour wood. 8 17x22 mm ribs. Dralon fabric 200 gr/m<sup>2</sup> without valance / without airvent.
- Bois avec vernis couleur teck. 8 baleines 17x22 mm. Tissu Dralon 220gr/m<sup>2</sup> sans volant / sans soufflet à vent.

5B2 4B2 7 T.55/70  
10 T.55/70 14 T.55/70

Apertura por poleas. Abertura por roldanas. Pulley opening system. Ouverture pour poulie

# Java

SPMD00C2000040P

300x300/8-4  
200x200/8-4



2B2  
7 T.70  
10 T.70  
14 T.70

5B2



300x300 cm



200x200 cm

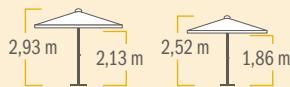

T. 60 mm Ø - T. 38 mm Ø

- Madera barnizada color teka. 8 varillas 17x35 mm (300x300 cm) - 17x21 mm (200x200 cm). Tejido Dralon 200 gr/m<sup>2</sup> con volante / sin fugavientos.
- Madeira vernizada cor teka. 8 varetas 17x35 mm (300x300 cm) - 17x21 mm (200x200 cm). Tecido Dralon 200 gr/m<sup>2</sup> com babinela / sem fugavientos
- Varnished teak colour wood. 8 17x35 mm (300x300 cm) - 17x21 mm (200x200 cm) ribs. Dralon fabric 200 gr/m<sup>2</sup> with valance / without airvent.
- Bois avec vernis couleur teck. 8 baleines 17x35 mm (300x300 cm) - 17x21 mm (200x200 cm). Tissu Dralon 220gr/m<sup>2</sup> avec volant / sans soufflet à vent.

Apertura por poleas. Abertura por roldanas. Pulley opening system. Ouverture pour poulie

# Java

SPMD00C2000020P

300x300/8-2  
200x200/8-2



2B2  
7 T.70  
10 T.70  
14 T.70

5B2



300x300 cm



200x200 cm

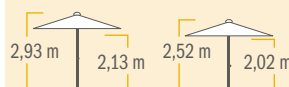

T. 60 mm Ø - T. 38 mm Ø

- Madera barnizada color teka. 8 varillas 17x35 mm (300x300 cm) - 17x21 mm (200x200 cm). Tejido Dralon 200 gr/m<sup>2</sup> sin volante / sin fugavientos.
- Madeira vernizada cor teka. 8 varetas 17x35 mm (300x300 cm) - 17x21 mm (200x200 cm). Tecido Dralon 200 gr/m<sup>2</sup> sem babinela / sem fugavientos
- Varnished teak colour wood. 8 17x35 mm (300x300 cm) - 17x21 mm (200x200 cm) ribs. Dralon fabric 200 gr/m<sup>2</sup> without valance / without airvent.
- Bois avec vernis couleur teck. 8 baleines 17x35 mm (300x300 cm) - 17x21 mm (200x200 cm). Tissu Dralon 220gr/m<sup>2</sup> sans volant / sans soufflet à vent.

Apertura por poleas. Abertura por roldanas. Pulley opening system. Ouverture pour poulie

## Colores tejido / cores tecido / fabric colours / couleurs tissu



# Java

SGMD00H3000040P

300x200/6-4

4B2 7 T.55 10 T.55 14 T.55

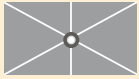

300x200 cm



T. 48 mm ø

- Madera barnizada color teka. 6 varillas 17x22 mm. Tejido Dralon 200 gr/m<sup>2</sup> con volante / sin fugavientos.
- Madeira vernizada cor teka. 6 varetas 17x22 mm. Tecido Dralon 200 gr/m<sup>2</sup> com bambinela / sem fugavientos
- Varnished teak colour wood. 6 17x22 mm ribs. Dralon fabric 200 gr/m<sup>2</sup> with valance / without airvent.
- Bois avec vernis couleur teck. 6 baleines 17x22 mm. Tissu Dralon 220gr/m2 avec volant / sans soufflet à vent.

Apertura por poleas. Abertura por roldanas. Pulley opening system. Ouverture pour poulie

# Java

SGMD00H3000020P

300x200/6-2

4B2 7 T.55 10 T.55 14 T.55

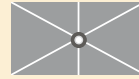

300x200 cm



T. 48 mm ø

- Madera barnizada color teka. 6 varillas 17x22 mm. Tejido Dralon 200 gr/m<sup>2</sup> sin volante / sin fugavientos.
- Madeira vernizada cor teka. 6 varetas 17x22 mm. Tecido Dralon 200 gr/m<sup>2</sup> sem bambinela / sem fugavientos
- Varnished teak colour wood. 6 17x22 mm ribs. Dralon fabric 200 gr/m<sup>2</sup> without valance / without airvent.
- Bois avec vernis couleur teck. 6 baleines 17x22 mm. Tissu Dralon 220gr/m2 sans volant / sans soufflet à vent.

Apertura por poleas. Abertura por roldanas. Pulley opening system. Ouverture pour poulie

# Palloza

SPSZ02D2005000T

ø 200/10



- Acero acabado madera. 10 varillas de fibra de vidrio. Inclinación metálica.
- Aço imitação madeira. 10 varetas de fibra de vidro. Inclinação metálica.
- Wood finishing steel. 10 fiberglass ribs. Metal tilt.
- Acier finition bois. 10 baleines en fibre de verre. Inclinaison métallique.

1 4B1



T. 29/32 mm ø



ø 200 cm



4 u.

835

NEGRO

844

BLANCO

**dralon**  
a step ahead in acrylic fibers

**made in Green**  
by AITEX

Nº 08AN5791



Bases / pieds pag. 80

000

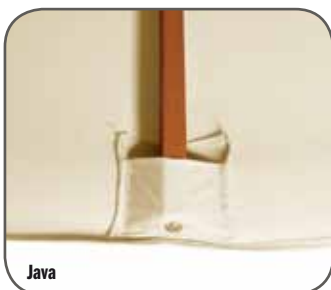

Java

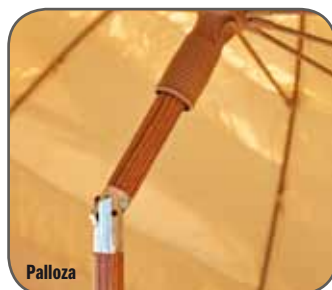

Palloza



Palloza



Palloza

# Complements

## **SERIES**

Maui

Siena

Bases parasol



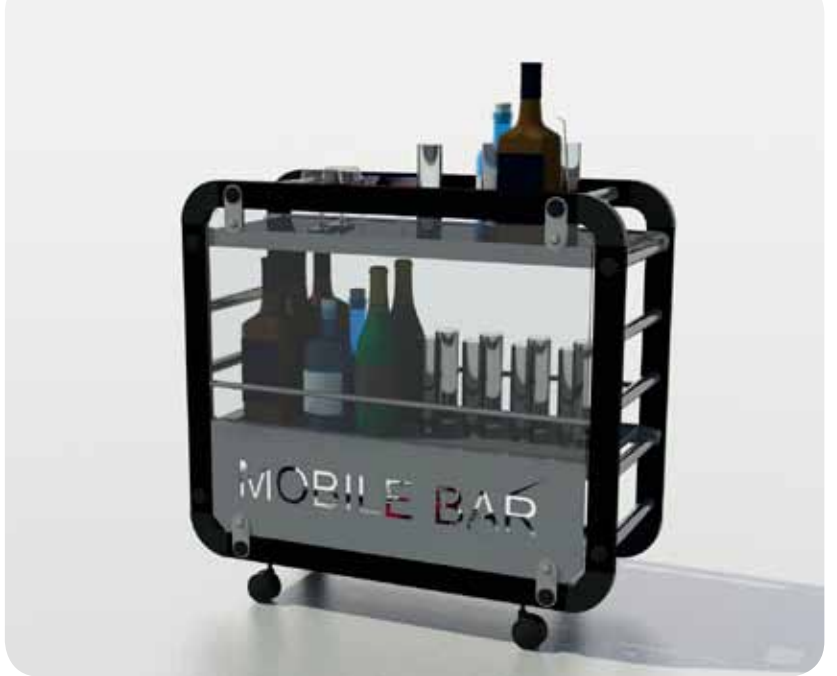

# Maui - Siena



## Maui MO-MAU00 - MO-MAU01

ES Separador de ambiente madera de pino y metacrilato.

PT Separador de ambiente madeira de pinho e metacrilato.

EN Pine wood and methacrylate Outdoor space divider.

FR Séparateur d'ambiance de pin et methacrylate.

250 X 160 cm

200 X 160 cm

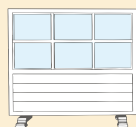
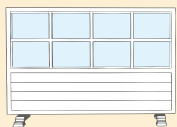

## Siena MO-SIE32

ES Carro camarera. Aluminio negro y anodizado. Tornillería acero inox lacada negro. Conexiones en poliamida con fibra de vidrio. Metacrilato. Compacto.

PT Carro serviço de mesa. Alumínio preto e anodizado. Acessórios em aço inox. lacada preto. Conexões em poliamida com fibra de vidro. Metacrilato. Compacto.

EN Waiter's car. Black and anodized aluminium. Black lacquered stainless steel screws. Polyamide with fiberglass connecting piece. Methacrylate. Compact.

FR Voiture service de table. Aluminium noir et anodisé. Visserie en acier inox laqué noir. Connexions en polyamide avec fibre de verre. Methacrylate. Compact.

100 X 40 X 93 cm

**COMPACT**



## Siena MO-SIE120

ES Barra de bar. Aluminio negro y anodizado. Tornillería acero inox lacada negro. Conexiones en poliamida con fibra de vidrio. Compacto.

PT Balcão de bar Alumínio preto e anodizado. Acessórios em aço inox. lacada preto. Conexões em poliamida com fibra de vidro. Compacto.

EN Bar. Black and anodized aluminium. Black lacquered stainless steel screws. Polyamide with fiberglass connecting piece. Compact.

FR Bar. Aluminium noir et anodisé. Visserie en acier inox laqué noir. Connexions en polyamide avec fibre de verre. Compact.

185 X 55 X 110 cm

**COMPACT**



## Siena Maxi MO-MSIE05

- Módulo separador. Aluminio negro y anodizado. Tornillería acero inox. Metacrilato. Bandeja. 6 Ruedas (3 con freno).
- Módulo separador. Alumínio preto e anodizado. Acessórios em aço inox. Metacrilato. Bandeja. 6 Rodas (3 com travão).
- Divider module. Black and anodized aluminium. Stainless steel hardware. Methacrylate. Plate. 6 Wheels (3 with brake).
- Module séparateur. Aluminium noir et anodisé. Visserie en acier inox. Methacrylate. Plateau. 6 Roues (3 avec frein).

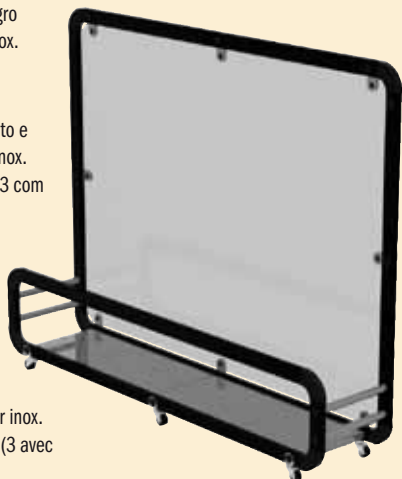

medidas / medidas / measures / mesures  
180 X 140 cm

## Siena Maxi MO-DOOSIE05 MO-VD00SIE05

- Módulo separador. Aluminio negro y anodizado. Tornillería acero inox. Tejido Dralon (con o sin ventana). Bandeja. 6 Ruedas (3 con freno).
- Módulo separador. Alumínio preto e anodizado. Acessórios em aço inox. Tecido Dralon (com ou sem janela). Bandeja. 6 Rodas (3 com travão).
- Divider module. Black and anodized aluminium. Stainless steel hardware. Dralon fabric (with or without window). Plate. 6 Wheels (3 with brake).
- Module séparateur. Aluminium noir et anodisé. Visserie en acier inox. Tissu Dralon (avec ou sans fenêtre). Plateau. 6 Roues (3 avec frein).

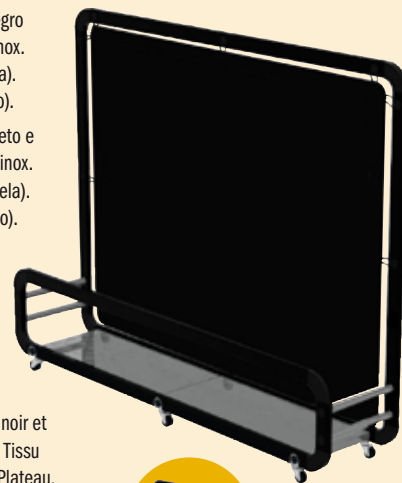

medidas / medidas / measures / mesures  
180 X 140 cm



**dralon®**  
a step ahead in acrylic fibers

## Siena Maxi MO-MSIE03

- Panel separador. Aluminio negro y anodizado. Tornillería acero inox. Metacrilato. 1 rueda con freno.
- Painel separador. Alumínio preto e anodizado. Acessórios em aço inox. Metacrilato. 1 roda com travão.
- Divider panel. Black and anodized aluminium. Stainless steel hardware. Methacrylate. 1 wheel with brake.
- Panneau séparateur. Aluminium noir et anodisé. Visserie en acier inox. Methacrylate. 1 roue avec frein.

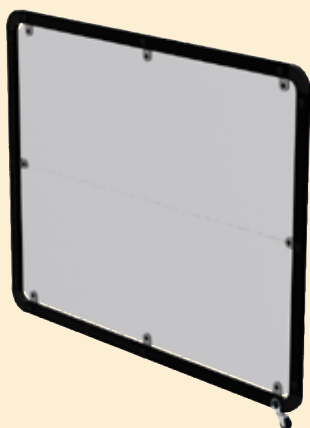

medidas / medidas / measures / mesures  
180 X 140 cm

## Siena Maxi MO-DOOSIE03 MO-VD00SIE03

- Panel separador. Aluminio negro y anodizado. Tornillería acero inox. Tejido Dralon (con o sin ventana). 1 rueda con freno.
- Painel separador. Alumínio preto e anodizado. Acessórios em aço inox. Tecido Dralon (com ou sem janela). Bandeja. 1 roda com travão.
- Divider panel. Black and anodized aluminium. Stainless steel hardware. Dralon fabric (with or without window). 1 wheel with brake.
- Panneau séparateur. Aluminium noir et anodisé. Visserie en acier inox. Tissu Dralon (avec ou sans fenêtre). 1 roue avec frein.

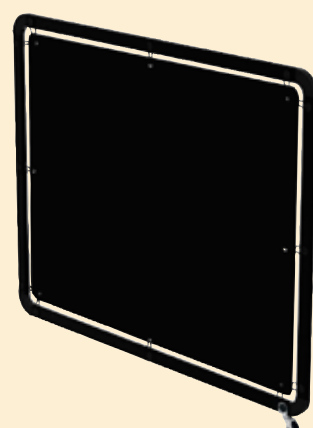

medidas / medidas / measures / mesures  
180 X 140 cm



**dralon®**  
a step ahead in acrylic fibers



**MO-SIE41**  
Rueda con freno/roda com travão/wheels with brake/roue avec frein



**52026**  
Pernio individual/dobradiça individual/  
individual fittings/joint flexible individuel



**MO-SIE52**  
Pernio para pared/dobradiça para  
pared/wall fitting/joint flexible pour mur



**MO-SIE30**  
Jardinería/jardineira/flowerpot/jardinière - 75x28x26 cm



**MO-SIE90 (mini) - MO-SIE91 (maxi)**  
Vinilo decorativo/vinilo decorativo/decorative  
Vinyl/vinil decoratif



**MO-SIE60**  
LED tubular (transformador y cable a red)/LED tubular (transformador  
e cabo à rede)/tubular LED (transformer and cable to network)/LED  
tubulaire (transformateur et cable de reseau)



## Siena Mini MO-MSIE06

- Módulo separador. Aluminio negro y anodizado. Tornillería acero inox. Metacrilato. Bandeja. 4 Ruedas (2 con freno).
- Módulo separador. Aluminio preto e anodizado. Acessórios em aço inox. Metacrilato. Bandeja. 4 Rodas (2 com travão).
- Divider module. Black and anodized aluminium. Stainless steel hardware. Methacrylate. Plate. 4 Wheels (2 with brake).
- Module séparateur. Aluminium noir et anodisé. Visserie en acier inox. Methacrylate. Plateau. 4 Roues (2 avec frein).



medidas / medidas / mesures / mesures  
101 X 140 cm

## Siena Mini MO-DOOSIE06 MO-VD00SIE06

- Módulo separador. Aluminio negro y anodizado. Tornillería acero inox. Tejido Dralon (con o sin ventana). Bandeja. 4 Ruedas (2 con freno).
- Módulo separador. Aluminio preto e anodizado. Acessórios em aço inox. Tecido Dralon (com ou sem janela). Bandeja. 4 Rodas (2 com travão).
- Divider module. Black and anodized aluminium. Stainless steel hardware. Dralon fabric (with or without window). Plate. 4 Wheels (2 with brake).
- Module séparateur. Aluminium noir et anodisé. Visserie en acier inox. Tissu Dralon (avec ou sans fenêtre). Plateau. 4 Roues (2 avec frein).



**dralon®**  
a step ahead in acrylic fibers

medidas / medidas / mesures / mesures  
101 X 140 cm

## Siena Mini MO-MSIE04

- Panel separador. Aluminio negro y anodizado. Tornillería acero inox. Metacrilato. 1 rueda con freno.
- Painel separador. Aluminio preto e anodizado. Acessórios em aço inox. Metacrilato. 1 Roda com travão.
- Divider panel. Black and anodized aluminium. Stainless steel hardware. Methacrylate. 1 Wheel with brake.
- Panneau séparateur. Aluminium noir et anodisé. Visserie en acier inox. Methacrylate. 1 Roue avec frein.

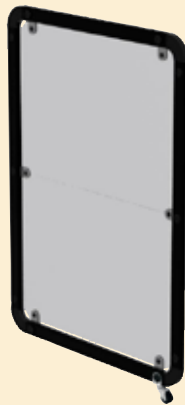

medidas / medidas / mesures / mesures  
101 X 140 cm

## Siena Mini MO-DOOSIE04 MO-VD00SIE04

- Panel separador. Aluminio negro y anodizado. Tornillería acero inox. Tejido Dralon (con o sin ventana). 1 Ruedas con freno.
- Painel separador. Aluminio preto e anodizado. Acessórios em aço inox. Tecido Dralon (com ou sem janela). Bandeja. 1 Roda com travão.
- Divider panel. Black and anodized aluminium. Stainless steel hardware. Dralon fabric (with or without window). 1 Wheel with brake.
- Panneau séparateur. Aluminium noir et anodisé. Visserie en acier inox. Tissu Dralon (avec ou sans fenêtre). 1 Roue avec frein.

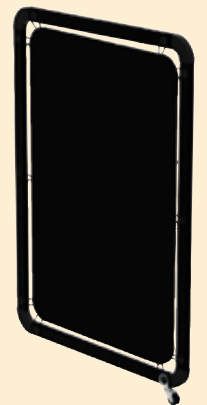

**dralon®**  
a step ahead in acrylic fibers

medidas / medidas / mesures / mesures  
101 X 140 cm



## Hierro / Ferro / Iron / Fer

NEW



**BSR700BC5500 / BSR700BC7000**  
Blanco/Branco/White/Blanc  
**BSR7000X5500 / BSR7000X7000**  
Óxido/Rust/Rouille  
**BSR700GR5500 / BSR700GR7000**  
Gris/Cinza/Grey/Gris

2A1 2A2 2B1 2B2 2C1 2C2

ø 70 cm x 6 mm  
tubo/tube ø 55 mm / ø 70 mm  
20 kg



**BSC625BC4000 / BSC625BC5500**  
Blanco/Branco/White/Blanc  
**BSC6250X4000 / BSC6250X5500**  
Óxido/Rust/Rouille  
**BSC625GR4000 / BSC625GR5500**  
Gris/Cinza/Grey/Gris

4A1 4A2 4B1 4B2 4C1 4C2

62,5 x 62,5 cm x 5,5 mm  
tubo/tube ø 40 mm / ø 55 mm  
18 kg



**BS0500BC4001 / BS0500BC4500**  
Blanco/Branco/White/Blanc  
**BS05000X4000 / BS05000X4500**  
Óxido/Rust/Rouille  
**BS0500GR4000 / BS0500GR4500**  
Gris/Cinza/Grey/Gris

5A1 5A2 5B1 5B2 5C1 5C2

50 x 50 cm x 6 mm  
tubo/tube ø 40 mm / ø 45 mm  
12 kg



**BSC625BC5700**  
Blanco/Branco/White/Blanc  
**BSC625GR5700**  
Gris/Cinza/Grey/Gris

4A3 4C3

34 kg

62,5 x 62,5 cm x 10 mm  
tubo/tube ø 57 mm  
34 kg

## Polipropileno / polypropylene / polypropylène



**BXC048BC00**  
Blanco/Branco/White/Blanc

1

50 x 50 cm x 33 mm  
tubo/tube ø 35 mm  
3/18 kg



**BXH097GR00 (Ipanema)**  
Gris/Cinza/Grey/Gris

12

97,5 x 82,5 x 20,5 mm  
tubo/tube ø 65 mm  
16/80 kg



**BXC086GR00 (Río)**  
Gris/Cinza/Grey/Gris

13

86 x 86 x 24 cm  
16/81 kg

## Cemento / Cimento / Concrete / Ciment



**BEC020GR00**  
Gris/Cinza/Grey/Gris

6

27,5 x 27,5 x 20 cm  
tubo/tube ø 26 mm  
22 kg

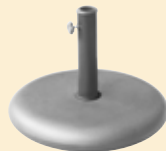

**BER048GC01**  
Gris/Cinza/Grey/Gris

8

ø 48 cm  
tubo/tube ø 55 mm  
25 kg



**BEC047BC00**  
Blanco/Branco/White/Blanc

11A

47 x 47 x 5 cm  
Parasol Flexo  
100 kg

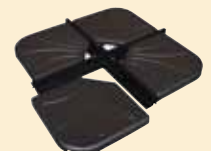

**BEC047NG00**  
Negro/Preto/Black/Noir

11B

47 x 47 x 5 cm  
Parasol Flexo  
100 kg

## Especiales / Especiales / Specials / Spécials



**BSC310GR5500/BSC310GR6000**  
**BSC310GR7000/BSC310GR8500**  
Gris/Cinza/Grey/Gris

10

31 x 31 cm x 6 mm  
tubo/tube ø 55/60/70/85 mm  
10 kg

Base hierro para atornillar / base ferro para fixar / iron base to fix / base fer pour visser



**BSRD5500/BSRD6000/BSRD7000**  
**BSRD8500 + BEC047NG00**  
Gris/Cinza/Grey/Gris

14

tubo/tube ø 55/60/70/85 mm  
110 kg

Base ruedas con piedras Flexo / base rodas con pedras Flexo / wheel base with Flexo stones / base roues avec pierres Flexo



**BIFC5500/BIFC6000**  
**BIFC6350/BIFC7000**  
Inox

7

tubo/tube ø 55/60/63,5/70 mm

Base "fast-click" de empotrar inox / base "fast-click" de encaixar inox / "fast-click" inox base to fix / base "fast-click" pour visser inox



**BER063GR00**  
Gris/Cinza/Grey/Gris

15

ø 60 cm  
tubo/tube ø 63 mm  
50 kg

Base cemento y hierro gris / Base cimento e ferro cinza / Grey concrete and iron base / Pied de parasol ciment et fer gris



### Contact us:

SPAIN	PORTUGAL	MEXICO	EXPORT
info@ezpeleta.com	ezpeleta.portugal@ezpeleta.com	ezpeleta.mexico@ezpeleta.com	export@ezpeleta.com
tel. +34 986 293 922	tel. +351 251 79 62 55	tel. +52 55 5520 2919 tel. +52 55 5520 5909	tel. +34 986 293 922

[www.ezpeleta.com](http://www.ezpeleta.com)

Ezpeleta se reserva el derecho a realizar modificaciones técnicas en los productos de este catálogo. A Ezpeleta reserva-se o direito de realizar qualquer alteração técnica nos produtos descritos neste catálogo. Ezpeleta reserves the right to change the technical characteristics and specifications of the product in this catalog. Ezpeleta se réserve le droit de réaliser des modifications techniques sur les produits décrits sur ce catalogue.



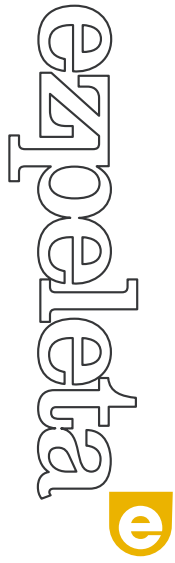

info@ezpeleta.com  
tel. +34 986 293922

[www.ezpeleta.com](http://www.ezpeleta.com)

**GRUPO EZPELETA**  
**SINCE 1935**

